

Fuller Heavy Duty Transmissions TRSM0917

October 2007



Powering Business Worldwide

BACKED BY

Roadranger

SUPPORT

For parts or service call us
Pro Gear & Transmission, Inc.



1 (877) 776-4600

(407) 872-1901

parts@eprogear.com

906 W. Gore St.

Orlando, FL 32805



Applications

Why Oil Cooling 1
 Why Operating Temperatures Rise 1
 Lowering Oil Temperature 1
 Applications for Oil Pumps and Coolers 1

Oil Pumps

Auxiliary Countershaft Oil Pumps /
 Helical Models 2
 Shimming Procedure 2
 Shimming Chart - 1 3
 Determining Endplay / Shimming
 Procedure 4
 Special Instructions 4
 The Shimming Procedure 4
 Final Check 5
 Auxiliary Countershaft Oil Pumps / Spur Gear
 Models with Tapered Roller Bearings 6
 Shimming Procedure 6
 Shimming Chart - 2 7

Determining Endplay / Shimming

Procedure 8
 Special Instructions 8
 The Shimming Procedure 8
 Final Check 9
 Integral Oil Pump 10
 How to Remove the Integral Oil Pump 10
 Integral Oil Pump 13
 How to Install the Integral Oil Pump 13

Cooling

Oil Cooler 16
 Optimum Cooling Efficiency 17

Lubrication

Proper Lubrication Procedures 18
 Proper Oil Level 18
 Recommended Lubricants and
 Maintenance Intervals 18

Why Oil Cooling

Eaton® Fuller® Transmissions are designed so that the internal parts operate in an oil/lubricant circulating bath created by the motion of the gears and shafts. Transmission lubricants oxidize rapidly and lose effectiveness when transmission temperatures exceed 250° F. The installation of Eaton Fuller oil pumps and coolers will increase oil flow and oil cooling, lowering temperatures to acceptable levels and prolonging the life of the lubricant.

Why Operating Temperatures Rise

The following conditions in any combination can cause operating temperatures of over 250°:

- operating consistently at low speeds
- high ambient temperatures
- restricted air flow around transmission
- exhaust system too close to transmission
- high horse power operation

Lowering Oil Temperature

Oil Pump Configurations

There are two kinds of oil pumps available from Eaton® Fuller® to assist in transmission oil cooling, **Auxiliary Countershaft Oil Pumps** and the **Integral Oil Pump**. Auxiliary Oil Pumps are installed externally, in place of the rear bearing cover on the lower countershaft at the right rear of the transmission. Integral Oil Pumps are installed internally, in the main case or front section of the transmission.

Integral Oil Pump

After January 1985, most transmissions with a nominal torque capacity of 1400 lbs. ft. have been offered with an optional Integral Oil pump. In most transmissions with a nominal torque capacity of 1500 lbs. ft. and above, the Integral Oil Pump is standard.

Auxiliary Countershaft Oil Pump

An Auxiliary Countershaft Oil Pump is available when an Integral Oil Pump cannot or has not been installed on a transmission and oil cooling is recommended/required.

Oil Cooler

Oil Coolers should be used when vehicle configuration and operating temperatures endanger oil effectiveness (see Applications for Oil Pumps and Coolers below). Oil Coolers operate at maximum cooling efficiency when mounted in a location that receives a direct flow of unheated air, for example, in front of the engine radiator. An Oil Filter can also be used, mounted in-line between the Oil Pump outlet and the Oil Cooler inlet.

Applications for Oil Pumps and Coolers

Oil Cooling is recommended with:

- engines 350 h.p. and above with overdrive transmissions.

Oil Cooling is required with:

- engines 399 h.p. and above with overdrive transmissions and Gross Combined Weights (GCW's) over 90,000 lbs.
- engines 399 h.p. and above the 1400 lbs. ft. or greater torque capacity.
- engines 450 h.p. and above.
- vehicles operating at speeds less than 20 miles per hour or near governed RPM's for periods exceeding 30 minutes, with ambient temperatures equal or greater than 70° F.

Auxiliary Countershaft Oil Pumps / Helical Models

Shimming Procedure

When shimming the Auxiliary Countershaft Oil Pump, use the appropriate Oil Pump Shims (see Shimming Chart - 1). Oil Pump Shims have a smaller outside diameter than the standard shims and are specially designed for use with Auxiliary Countershaft Oil Pumps. The shimming procedure can be done in the horizontal or vertical position. The procedure is the same. Shims must be aligned properly to prevent damage to the Oil Pump when final torque is applied.

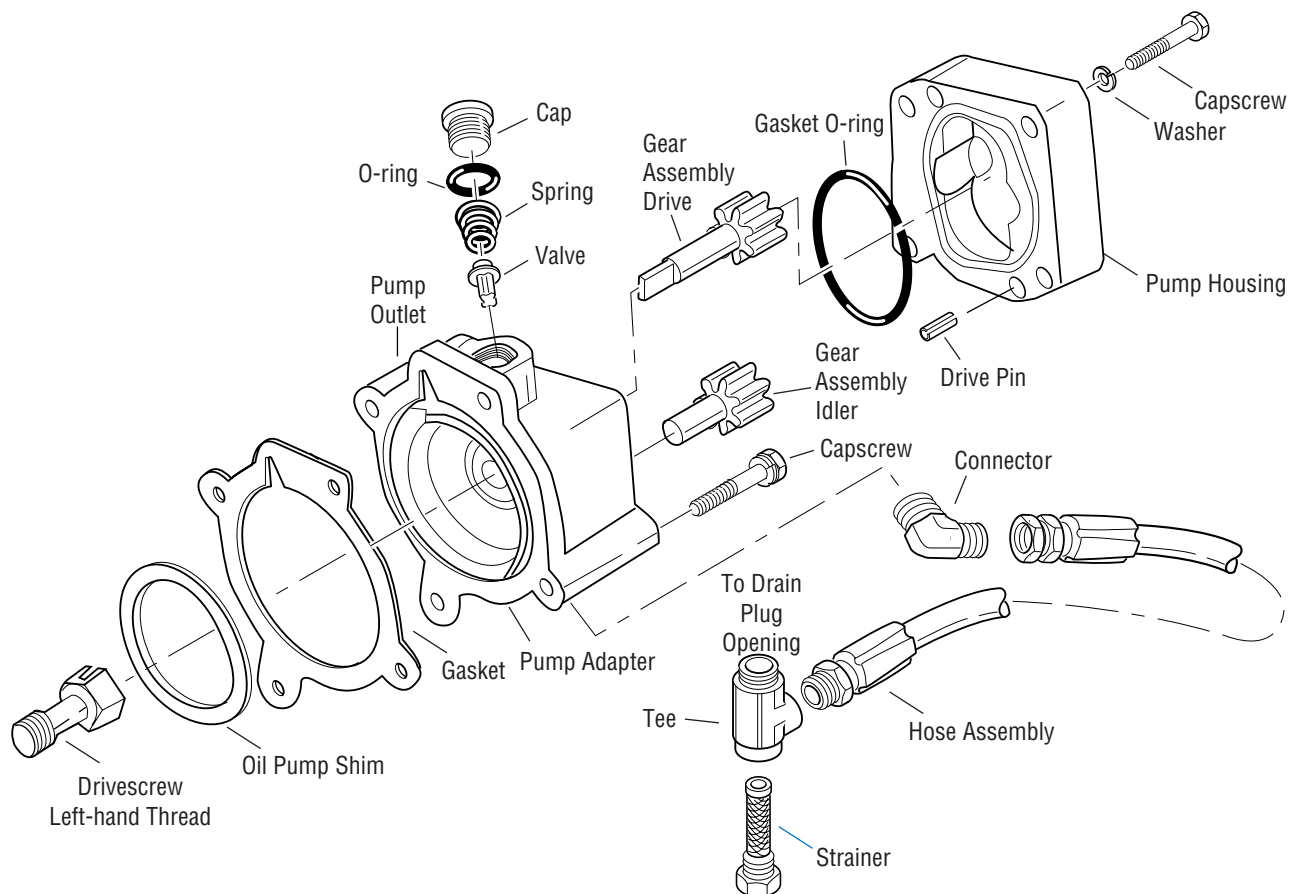

Shimming Chart - 1

Average the feeler gauge measurement and match the measurement to the feeler gauge average gap (column 1). Follow the column to the right to identify the shim thickness (column 2) to be used, part number (column 3), and color code (column 4) of the correct shim.

1 Feeler Gauge Average Gap	2 Shim Thickness	3 Oil Pump Shim Part Number	4 Color Code
.072 - .075	.036 - .037	21472	Red
.069 - .0715	.039 - .040	21473	Pink
.066 - .0685	.042 - .043	21474	Brown
.063 - .0655	.045 - .046	21475	Tan
.060 - .0625	.048 - .049	21476	Orange
.057 - .0595	.051 - .052	21477	Yellow
.054 - .0565	.054 - .055	21478	Green
.051 - .0535	.057 - .058	21479	Light Blue
.048 - .0505	.060 - .061	21480	Lavender
.045 - .0475	.063 - .064	21481	White
.042 - .0445	.066 - .067	21686	Black
.039 - .0415	.069 - .070	21687	Silver

Auxiliary Countershaft Oil Pumps / Helical Models

Determining Endplay / Shimming Procedure

When installing the Auxiliary Countershaft Oil Pump, use the existing rear bearing cover to measure the average feeler gauge gap (see Shimming Chart - 1 / column 1) and determine endplay for shimming procedure as follows:

Special Instructions

When the Auxiliary Countershaft Oil Pump is removed always install an auxiliary countershaft retaining strap with 2 - 3/8" NC X 1 and 1 - 3/8" NC X 2 - 1/2" clean capscrews to prevent the countershaft from falling. Do not use an air gun—tighten capscrews by hand until snug.

CAUTION: Use Retaining Straps to prevent injury or damage to transmission.

The Shimming Procedure

1. Remove the countershaft straps.

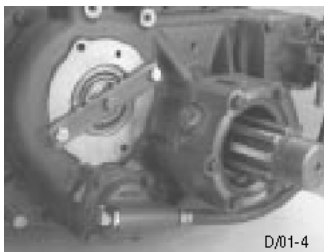

2. Install an .100 gauging shim to the countershaft rear bearing shim bore, making sure that the countershaft rear bearing races are seated in the bearing bores.

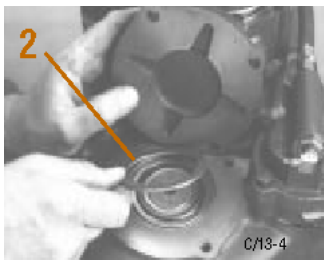

3. Do not install the countershaft rear bearing cover gasket. Position the rear bearing cover over the shim. Install two (2) clean 3/8" X 1" capscrews directly across from each other in the rear bearing cover.

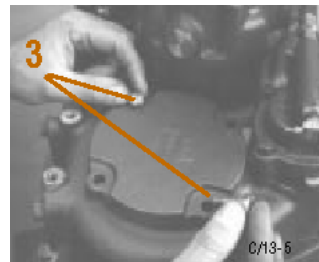

4. Tighten the capscrews to 7 lbs. in. of torque.

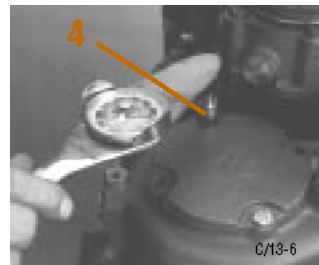

5. Rotate the output shaft six (6) times clockwise, then six (6) times counterclockwise to seat the countershaft bearings. Use a feeler gauge, as close to one capscrew location as possible, and measure the gap between the countershaft rear bearing cover and the auxiliary case. Record the measurement.
6. Measure the gap as close to the 2nd capscrew location as possible and record the measurement. Average the two measurements. Using the average measurement, refer to the Shimming Chart - 1 to identify the proper shim to be used in the countershaft bore.

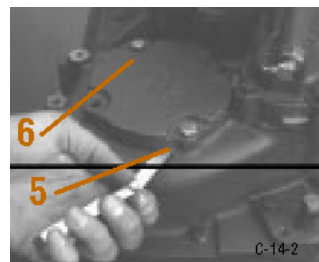

7. Remove the countershaft rear bearing covers and gauging shims.
8. Place the selected shim on the rear countershaft bearing race.
9. Position a new gasket on the assembled oil pump mounting surface.

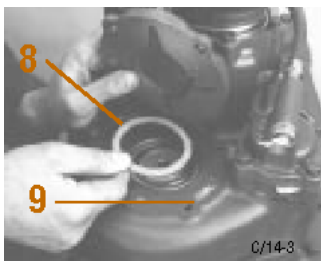

10. Install the assembled oil pump.

11. Apply Eaton® Fuller® Sealant #71205 or equivalent to the retaining capscrews.
12. Install the retaining capscrews and tighten to 35-45 lbs. ft. of torque.

10-12

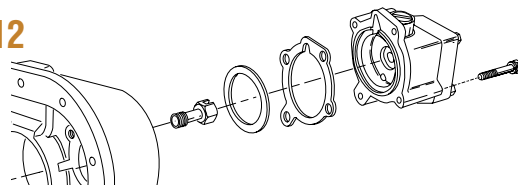

Final Check

Make sure capscrews are properly torqued. Make sure the input shaft rotates.

Auxiliary Countershaft Oil Pumps / Spur Gear Models with Tapered Roller Bearings

Shimming Procedure

When shimming the Auxiliary Countershaft Oil Pump, use the appropriate Oil Pump Shims (see Shimming Chart - 2). Oil Pump Shims have a smaller outside diameter than the standard shims and are specially designed for use with Auxiliary Countershaft Oil Pumps. Shimming procedure can be done in the horizontal or vertical position. The procedure is the same. Shims must be aligned properly to prevent damage to the Oil Pump when final torque is applied.

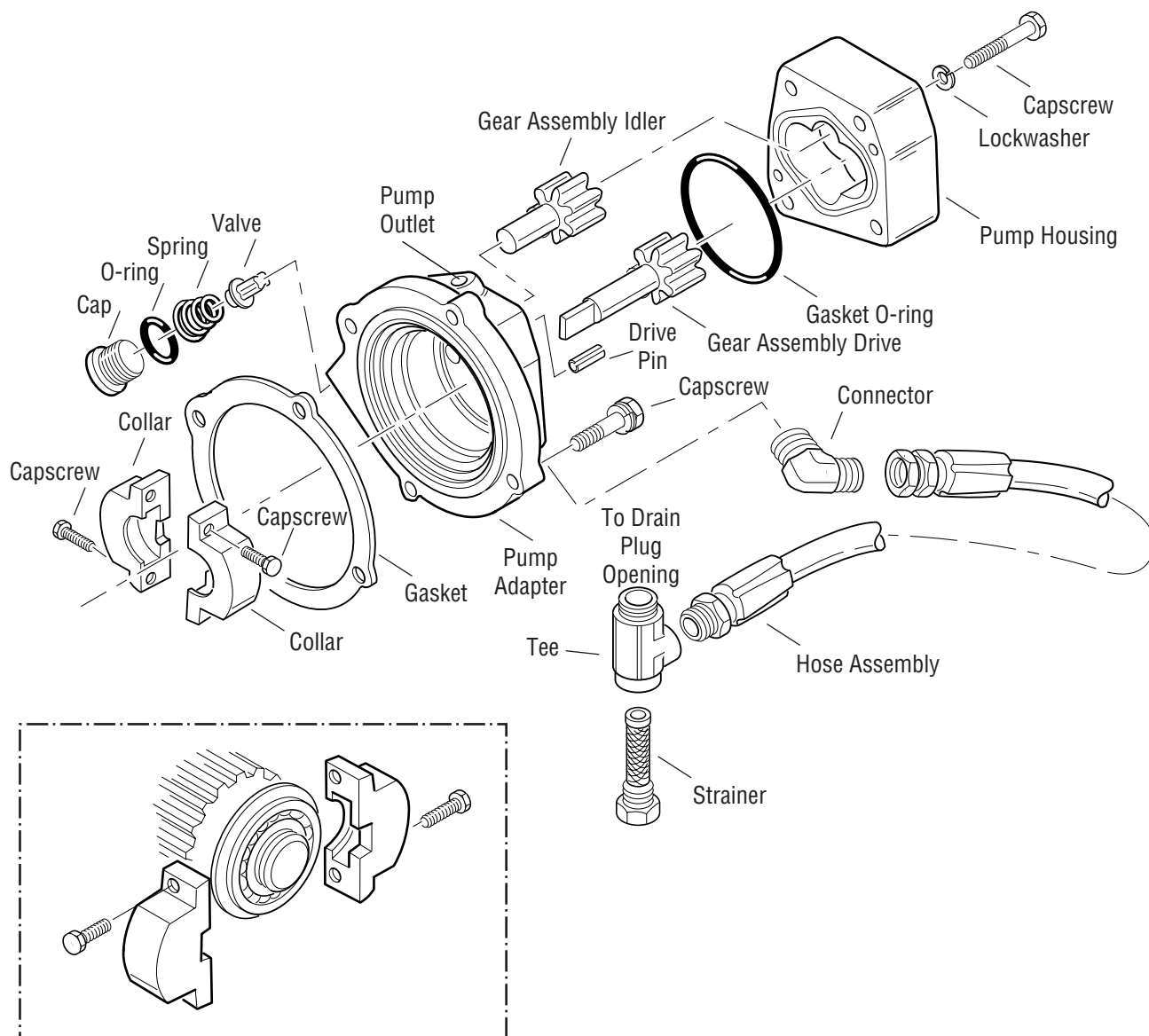

Shimming Chart - 2

Average the feeler gauge measurement and match the measurement to the feeler gauge average gap (column 1). Follow the column to the right to identify the shim thickness (column 2) to be used, part number (column 3), and color code (column 4) of the correct shim.

1 Feeler Gauge Average Gap	2 Shim Thickness	3 Oil Pump Shim Part Number	4 Color Code
.088 - .089	.042 - .043	21474	Brown
.085 - .0875	.045 - .046	21475	Tan
.082 - .0845	.048 - .049	21476	Orange
.079 - .0815	.051 - .052	21477	Yellow
.076 - .0785	.054 - .055	21478	Green
.073 - .0755	.057 - .058	21479	Light Blue
.070 - .0725	.060 - .061	21480	Lavender
.067 - .0695	.063 - .064	21481	White
.064 - .0665	.066 - .067	21686	Black
.061 - .0635	.069 - .070	21687	Silver
.058 - .0605	.072 - .074	21472+21472	Red+Red
.055 - .0575	.075 - .077	21472+21473	Red+Pink
.052 - .0545	.078 - .080	21472+21474	Red+Brown
.049 - .0515	.081 - .083	21472+21475	Red+Tan
.046 - .0485	.084 - .086	21472+21476	Red+Orange
.043 - .0455	.087 - .089	21472+21477	Red+Yellow
.040 - .0425	.090 - .092	21472+21478	Red+Green
.038 - .0395	.093 - .095	21472+21479	Red+Light Blue

Auxiliary Countershaft Oil Pumps / Spur Gear Models with Tapered Roller Bearings

Determining Endplay / Shimming Procedure

When installing the Auxiliary Countershaft Oil Pump, use the existing rear bearing cover to measure the average feeler gauge gap (see Shimming Chart - 2 / column 1) and determine endplay for shimming procedure as follows:

Special Instructions

When the Auxiliary Countershaft Oil Pump is removed always install an auxiliary countershaft retaining strap with 2 - 3/8" NC X 1 and 1 - 3/8" NC X 2 - 1/2" clean capscrews to prevent the countershaft from falling. Do not use an air gun—tighten capscrews by hand until snug.

CAUTION: Use Retaining Straps to prevent injury or damage to transmission.

The Shimming Procedure

1. Remove the countershaft straps.

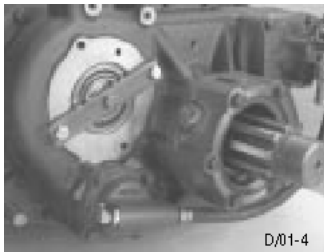

2. Install a .125 gauging shim to the countershaft rear bearing shim bore, making sure that the countershaft rear bearing races are seated in the bearing bores.

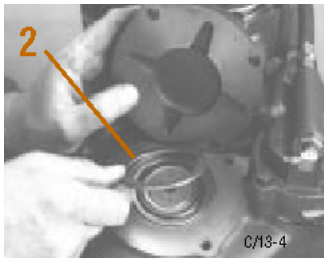

3. Do not install the countershaft rear bearing cover gasket. Position the rear bearing cover over the shim. Install two (2) clean 3/8" X 1" capscrews directly across from each other in the rear bearing cover.

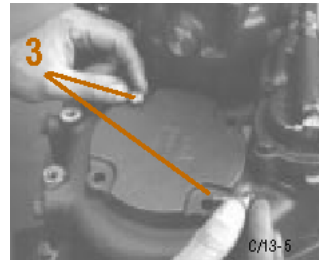

4. Tighten the capscrews to 7 lbs. in. of torque.

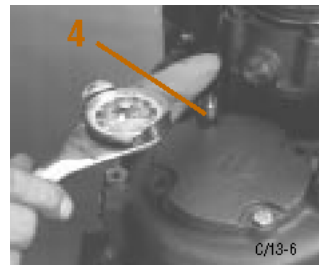

5. Rotate the output shaft six (6) times clockwise, then six (6) times counterclockwise to seat the countershaft bearings. Use a feeler gauge, as close to one capscrew location as possible, and measure the gap between the countershaft rear bearing cover and the auxiliary case. Record the measurement.
6. Measure the gap as close to the 2nd capscrew location as possible and record the measurement. Average the two measurements. Using the average measurement, refer to the Shimming Chart - 2 to identify the proper shim to be used in the countershaft bore.

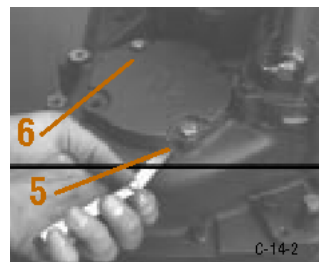

7. Remove the countershaft rear bearing covers and gauging shims.
8. Place the selected shim on the rear countershaft bearing race.
9. Position a new gasket on the assembled oil pump mounting surface.

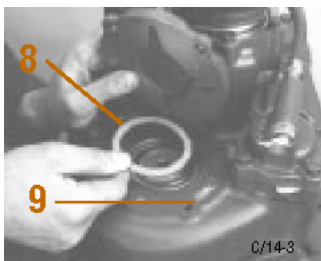

10. Install the assembled oil pump.

11. Apply Eaton® Fuller® Sealant #71205 or equivalent to the retaining capscrews.
12. Install the retaining capscrews, tighten to 35-45 lbs. ft. of torque.

10-12

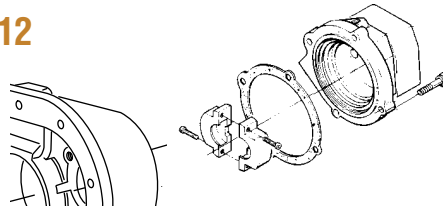

Final Check

Make sure capscrews are properly torqued. Make sure the input shaft rotates.

Integral Oil Pump

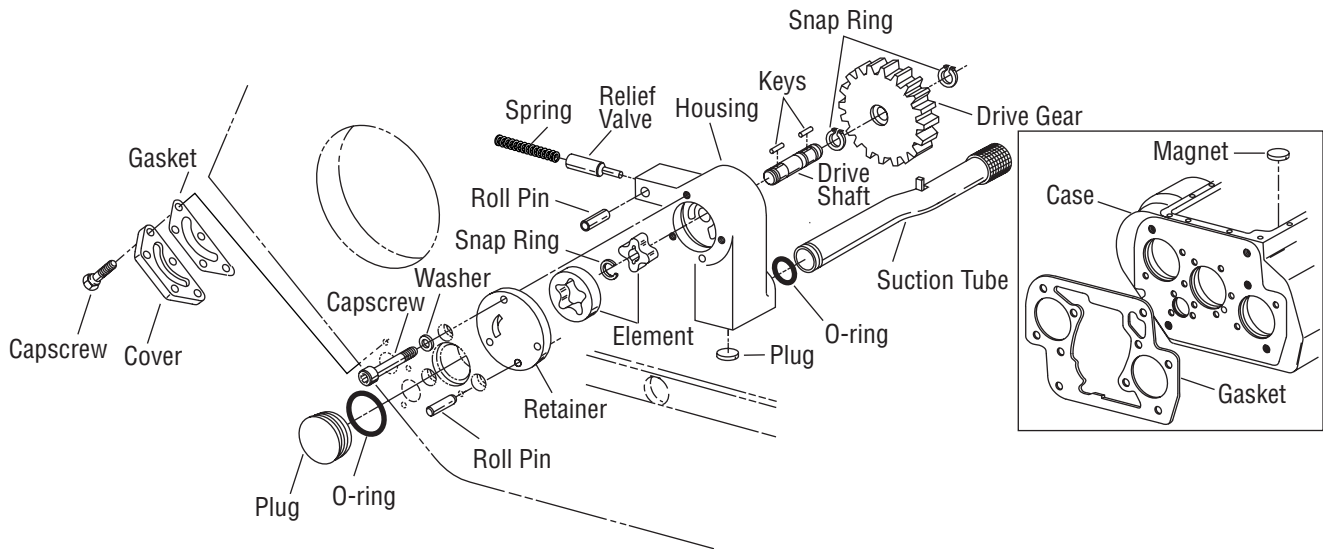

How to Remove the Integral Oil Pump

1. Straighten tube lock on suction tube.

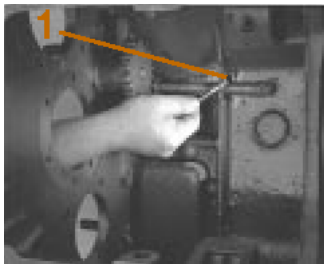

2. Remove suction tube from oil pump. If necessary, remove o-ring from suction tube.

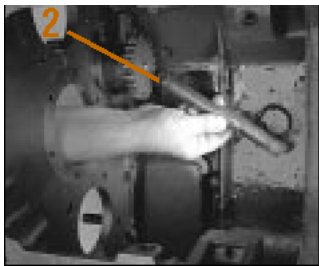

3. Remove three (3) allen head capscrews and washers that retain the integral oil pump to the case.

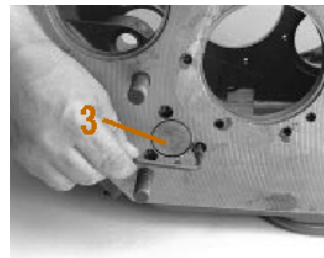

4. Remove the integral oil pump assembly from case.

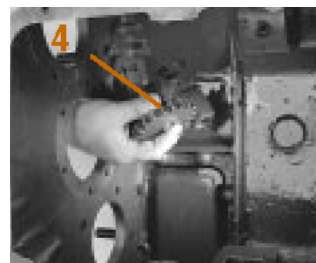

5. Remove integral oil pump retainer plate from case.

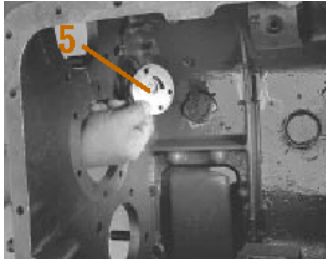

9. Remove key from drive shaft keyway.

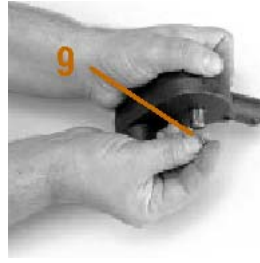

6. Remove outer oil pump element from pump.

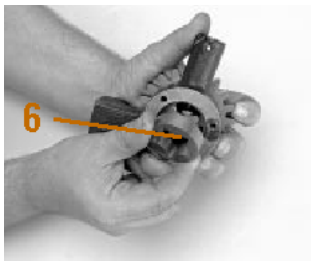

10. Remove element snap ring from drive shaft.



7. Remove drive gear retaining snap ring from drive shaft.

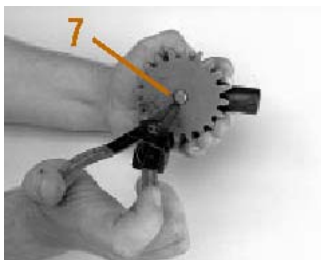

11. Remove internal oil pump element from drive shaft.

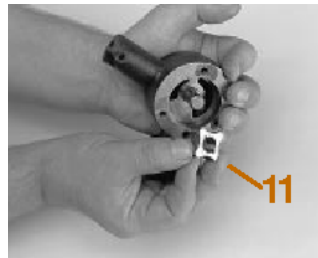

8. Remove drive gear from pump drive shaft.

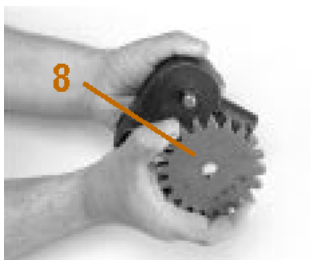

12. Remove two keys from drive shaft keyways.



13. Remove the drive shaft from integral oil pump housing. If necessary, remove rear drive gear retention snap ring from drive shaft.

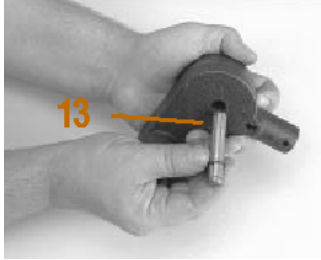

16. Remove relief valve from housing bore.

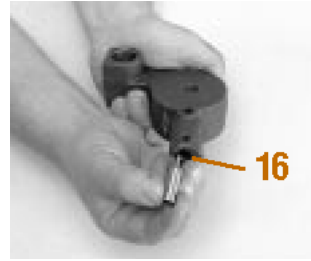

14. Remove relief valve roll pin from pump housing.

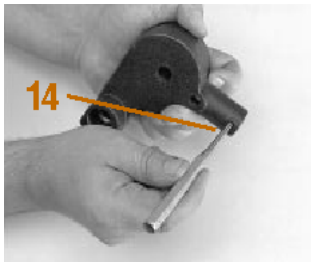

17. If necessary, front case plug can be removed from case by driving the plug through the front of case. Remove o-ring from outside diameter of plug if necessary.



15. The relief valve spring can now be removed from relief valve housing bore.

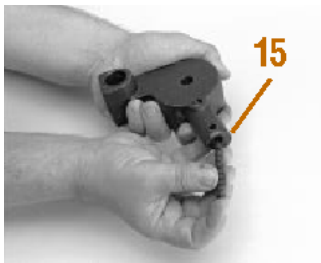

Integral Oil Pump

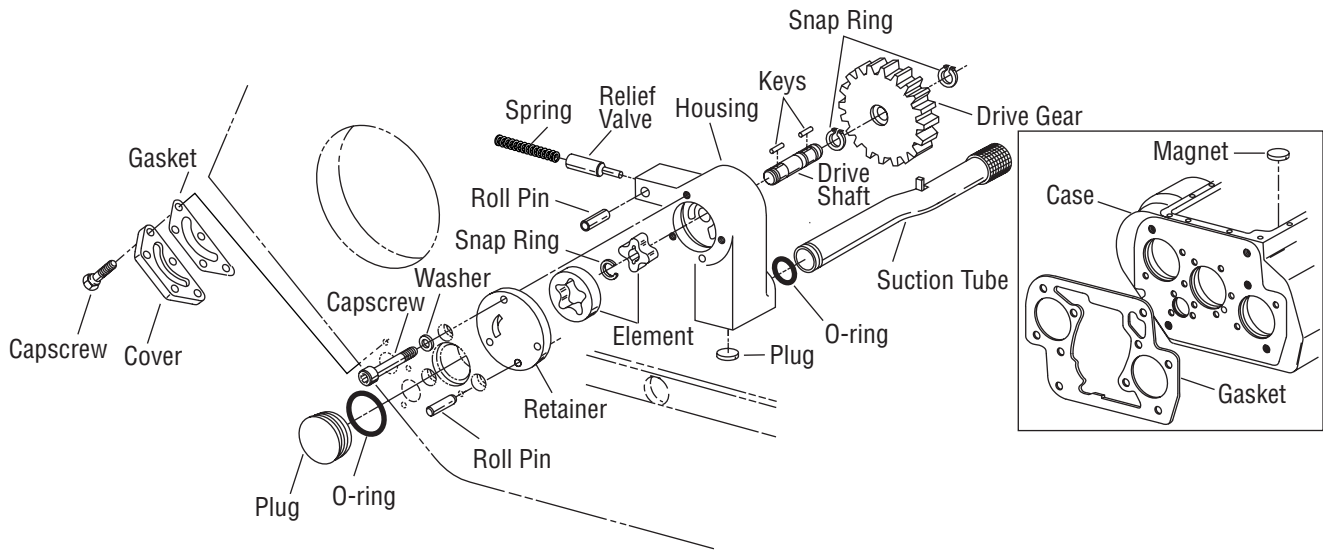

How to Install the Integral Oil Pump

1. Replace o-ring on front case plug.

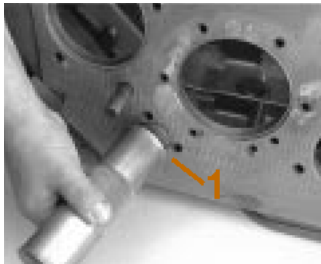

2. Install relief valve in integral oil pump housing.

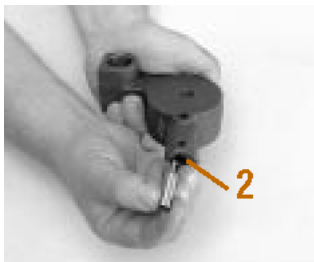

3. Install relief valve spring in oil pump housing.

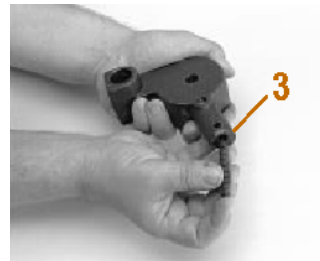

4. Secure oil pump housing in a vice. Depress spring in housing bore and relief valve retention roll pin into roll pin bore.

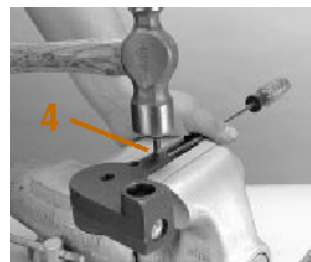

5. If removed, replace drive shaft snap ring on pump drive shaft and insert drive shaft through pump housing bore.

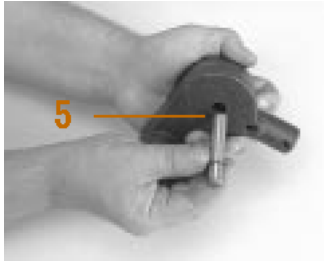

6. Install the two keys on drive shaft.



7. Install integral oil pump inner element on drive shaft, aligning round key on drive shaft with round keyway on inner element and square key on drive shaft with square keyway on inner element.

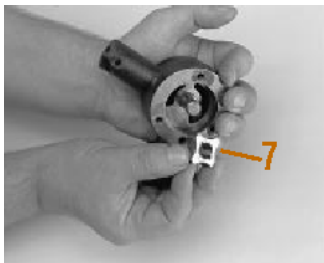

8. Install inner element retention snap ring in drive shaft snap ring groove.



9. Install drive gear key in keyway of drive shaft.



10. Install drive gear on drive shaft, aligning keyway on drive gear with key on drive shaft.

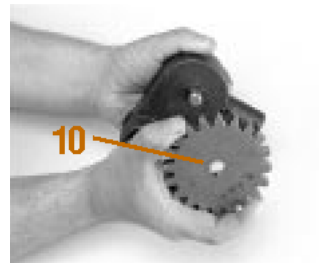

11. Install outer drive gear retention snap ring in the drive shaft groove.



12. Install outer integral oil pump element over inner element.



13. Install integral oil pump retainer over alignment pin inside of case, bore retainer facing rear of case.



15. Install three (3) capscrews and washers through case front and into pump housing, tighten capscrews to 8-12 lbs. ft. torque.

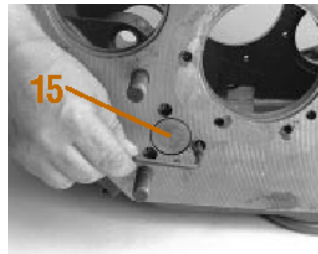

14. Install integral oil pump assembly in case aligning front face of oil pump with retainer and alignment pin.

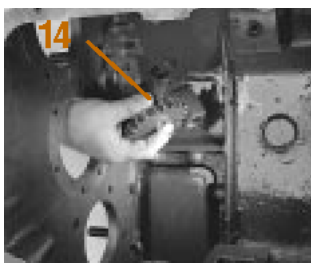

16. Replace o-ring on suction tube and install tube under case rib and into integral oil pump. Bend tube lock on suction tube over case rib.

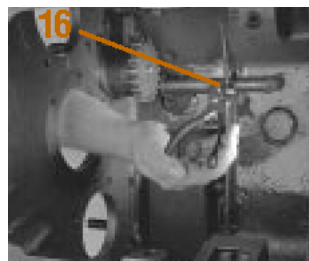

Oil Cooler

The transmission Oil Cooler on your vehicle is OEM installed.
For complete information on its location, installation, and components contact your OEM.

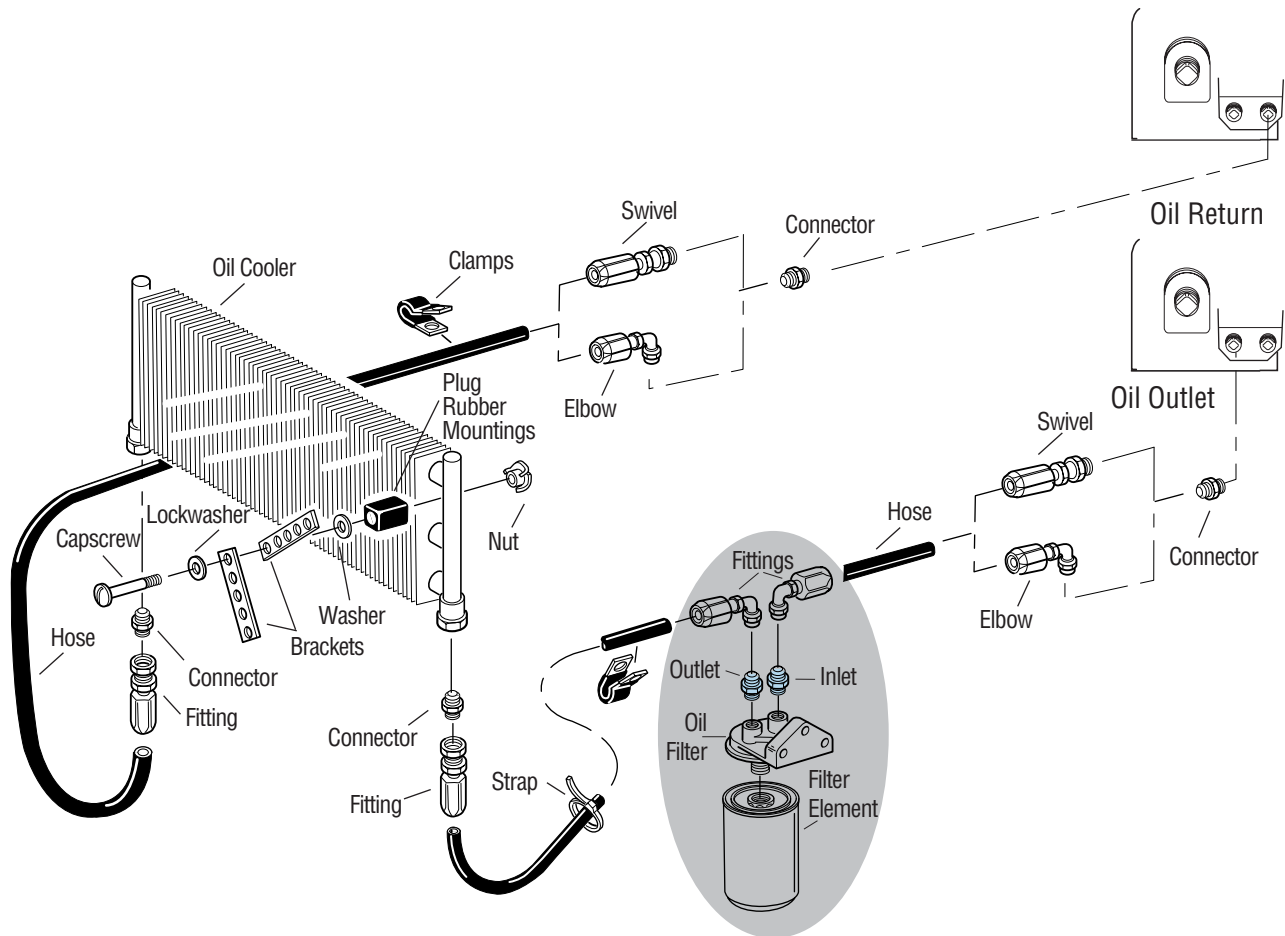

Optimum Cooling Efficiency

For optimum cooling efficiency it is advisable to mount the oil cooler in a location where it will receive a direct flow of unheated air — for instance in front of the engine radiator.

If the oil cooler is mounted on a moveable object, such as the front of a cabover model truck, the two lines to the oil cooler must be long enough to allow the object a full degree of movement without putting tension on the lines.

If an oil filter is used, it must be mounted in-line between the outlet on the oil pump and the inlet of the oil cooler. This prevents fouling of the cooler and insures peak performance of the system.

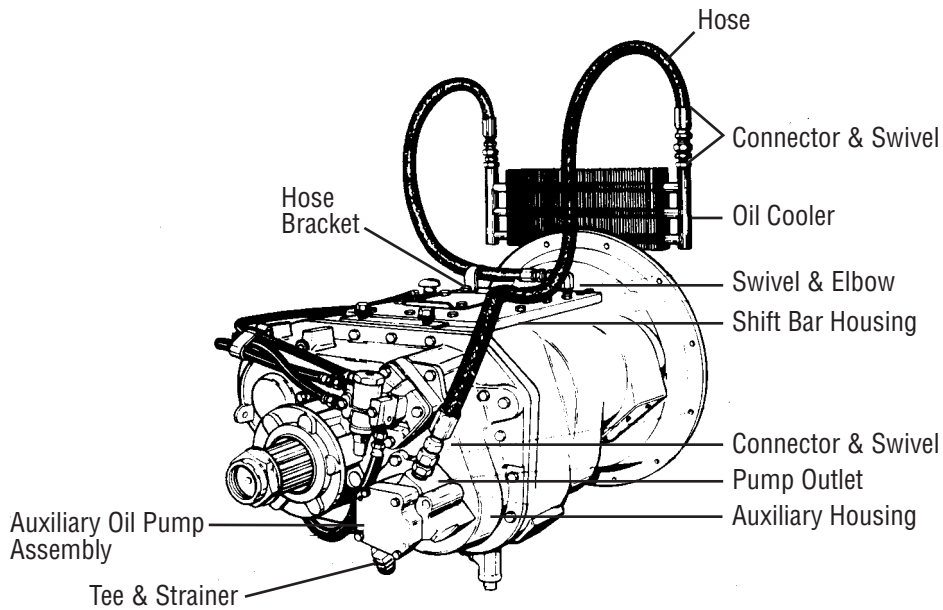

Proper Lubrication Procedures

Proper lubrication procedures are the key to a good all-around maintenance program. If the oil is not doing its job, or if the oil level is ignored, all the maintenance procedures in the world are not going to keep the transmission running or assure long transmission life. To insure proper lubrication follow these procedures closely:

1. Maintain oil level and inspect regularly.
2. Follow maintenance interval chart.
3. Use the correct grade and type of oil.
4. Buy from a reputable dealer.

Proper Oil Level

- Make sure oil is level with the filler opening. Because you can reach oil with your fingers does not mean oil is at proper level. (One inch of oil level is about one gallon of oil.)

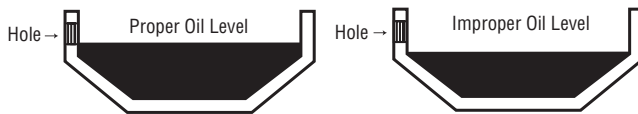

- When adding oil, types and brand of oil should not be mixed because of possible incompatibility.
- If your vehicle has a transmission oil filter, you must change the filter when fluid or lubricant is changed.

Recommended Lubricants and Maintenance Intervals

For a list of approved lubricants and intervals, see the Roadranger Products Approved Lubricants publication TCMT-0020 and the Roadranger Products Lubrication Manual TCMT-0021.

Copyright Eaton Corporation, 2012. Eaton hereby grant their customers, vendors, or distributors permission to freely copy, reproduce and/or distribute this document in printed format. It may be copied only in its entirety without any changes or modifications. THIS INFORMATION IS NOT INTENDED FOR SALE OR RESALE, AND THIS NOTICE MUST REMAIN ON ALL COPIES.

Note: Features and specifications listed in this document are subject to change without notice and represent the maximum capabilities of the software and products with all options installed. Although every attempt has been made to ensure the accuracy of information contained within, Eaton makes no representation about the completeness, correctness or accuracy and assumes no responsibility for any errors or omissions. Features and functionality may vary depending on selected options.

For spec'ing or service assistance, call 1-800-826-HELP (4357) or visit www.eaton.com/roadranger. In Mexico, call 001-800-826-4357.

Roadranger: Eaton and trusted partners providing the best products and services in the industry, ensuring more time on the road.

Eaton Corporation

Vehicle Group
P.O. Box 4013
Kalamazoo, MI 49003 USA
800-826-HELP (4357)
www.eaton.com/roadranger

Printed in USA

For parts or service call us
Pro Gear & Transmission, Inc.



1 (877) 776-4600

(407) 872-1901

parts@eprogear.com

906 W. Gore St.

Orlando, FL 32805

