

Fuller Mid Range Transmissions TRSM0194

October 2007



Powering Business Worldwide

BACKED BY

Roadranger

SUPPORT

For parts or service call us
Pro Gear & Transmission, Inc.



1 (877) 776-4600

(407) 872-1901

parts@eprogear.com

906 W. Gore St.

Orlando, FL 32805



Caution -

Before towing the vehicle, be sure to lift the rear wheels off the ground or disconnect the driveline to avoid damage to the transmission during towing.

FOREWARD

This manual has been prepared to provide the customer and the maintenance personnel with information and instructions on the maintenance and repair of the CLARK® Transmission.

Extreme care has been exercised in the design, selection of materials and manufacturing of these units. The slight outlay in personal attention and cost required to provide regular and proper lubrication, inspection at stated intervals, and such adjustments as may be indicated will be reimbursed many times in low cost operation and trouble free service.

In order to become familiar with the various parts of the transmission, its principle of operation, troubleshooting and adjustments, it is urged that the service person study the instructions in this manual carefully and use it as a reference when performing maintenance and repair operations.

Whenever repair or replacement of components parts is required, only Clark-approved parts as listed in the applicable parts manual should be used. Use of "will-fit" or non-approved parts may endanger proper operation and performance of the equipment. The Clark Equipment Company does not warrant repair or replacement parts, nor failures resulting from the use thereof, which are not supplied by or approved by the Clark Equipment Company.

IMPORTANT: Always furnish the Distributor with the transmission serial and model number when ordering parts.

THE CLARK SYNCHRONIZER AND HOW IT WORKS FOR YOU

The Clark split-pin synchronizer prevents the clashing of the gears and increase the speed of shifting.

In a conventional transmission which does not have synchronizers the absence of gear clashing is dependent entirely on the skill of the truck driver. By double-clutching and split second timing of engine speeds with the gear shifting movement, a driver can synchronize the speeds of the engaging gears and thereby prevent the damage to gears by clashing when a fast shift. The splint-pin sychronzier performs the same function with or without the "double-clutching" operating even though the driver does not accurately time his gear shifting movements. It also mechanically prevents the driver from completing the shift to the point of gear engagement until the engaging gears have reached the same or synchronous speeds. This is known as the blocking action of the synchronizer and it is this action that makes the operation of shifting a transmission having synchronizers different from one which does not have synchronizers.

Upon shifting gears in these synchronized transmissions the first part of the gear shift lever movement brings the blockers into contact. The blockers momentarily prevent further movement of the shift lever and the pressure exerted by the driver to complete the movement, is transferred by the blockers to the synchronizer providing the force necessary to synchronize the gears being engaged. When the engaging gears have reached the same speed, the blockers automatically disengage, permitting the gear shift lever movement to be completed. Therefore, to properly shift a synchronized transmission a steady and continuous pressure must be applied by the driver to the shift lever until the shift is completed. Under normal conditions this action is instantaneous.

Sometimes difficulty is experienced in shifting a synchronizer when the vehicle is standing still. This is caused by the fact that the disengagement of the blockers requires relative rotation and with the vehicle at rest and with the engine clutch released, there may be at times, no relative rotation of the engaging gears. Under these conditions, the same continuous pressure should be applied to the shift lever and at the same time, the clutch should be engaged slightly. This will give sufficient rotation to unblock the synchronizer and allow the shift to be completed without difficulty.

RECOMMENDED LUBRICANTS FOR CLARK MANUALLY SHIFTED TRANSMISSIONS

*MIL-L-2105C Extreme Pressure Lubricant (or API classification GL-5) of the SAE viscosity recommended in the chart at the right is preferred. All lubricants should be backed by the reputation of a well-know supplier. It is important to specify EP lubricants of the MIL-L-2105C type only, or of a API classification GL-5.

***Do not use extreme pressure lubricants other than MIL-L-2105C or of a API classification GL-5.**

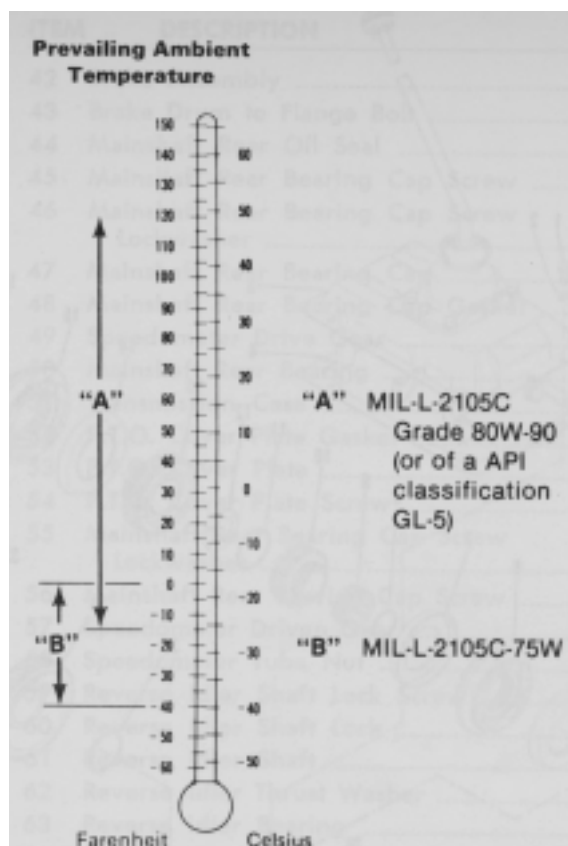
Many EP lubricants contain highly-active chemical compounds that have been formulated to perform satisfactorily in specific types of applications. Severe corrosion, residual deposits, and inadequate lubrication may result from improper application. Use of EP lubricants other that MIL-L-2105C or of a API classification GL-5 may result in failure and/or impaired operation.

DRAINING ECONOMY - The object in draining the transmission oil periodically is to eliminate possible bearing surface abrasion and attendant wear. Minute particles of metal, the product of normal wear in service, are deposited in and circulate with the transmission oil. The oil changes chemically, due to its repeated heating and cooling, also the terrific churning it undergoes in the presence of air. It is desirable to drain out this used oil after the first 1,000 miles (1609,0 Km) of service (regardless of type of service). Subsequent drains should be made every 24,000 miles (38616,0 Km) or six (6) months (whichever comes first) for highway service, and every 8,000 to 10,000 miles [12872,0-16090,0 Km] or six (6) months (whichever comes first) "on-off" highway and "pick-up and delivery" types of service. Do this only when the transmission is thoroughly warm.

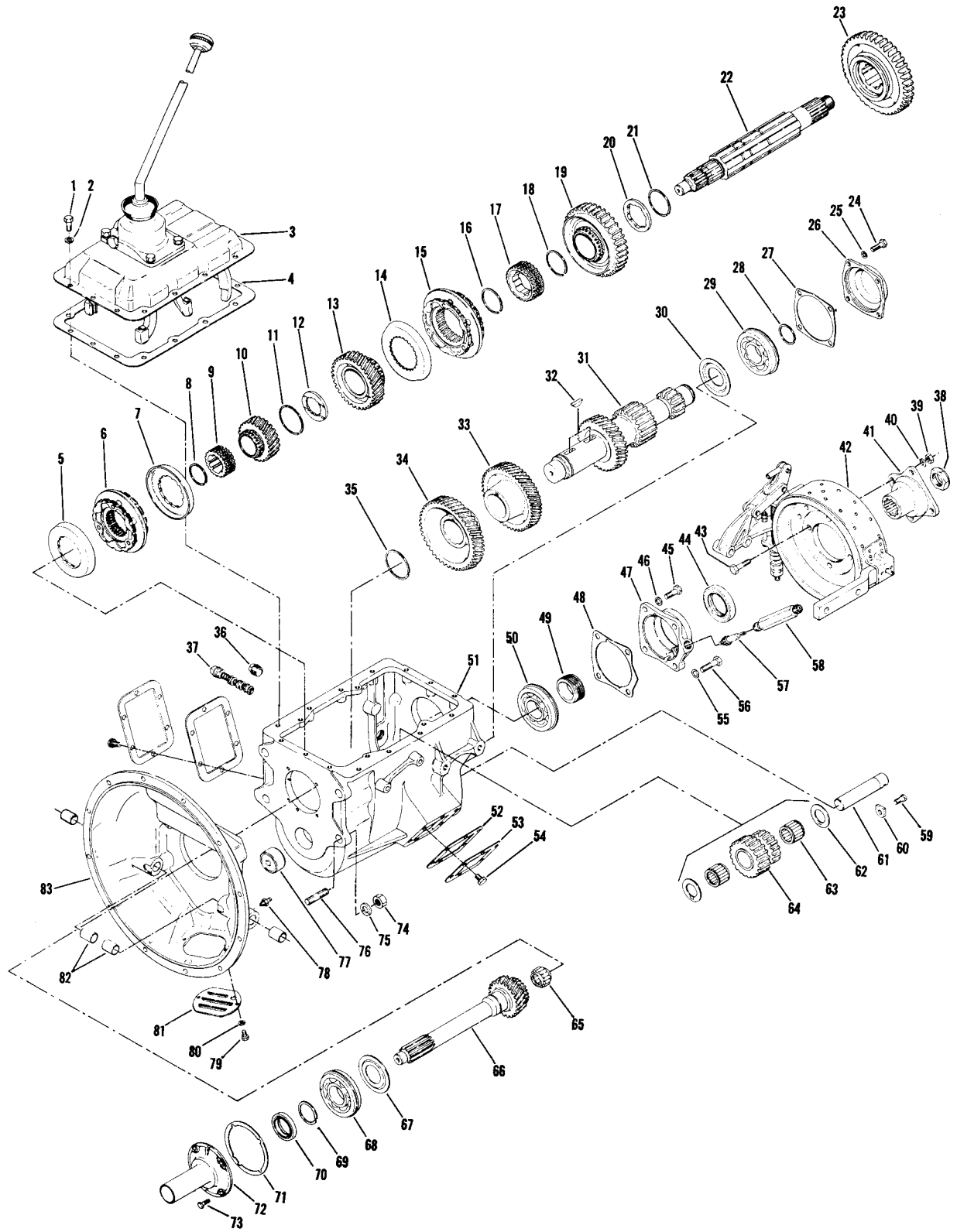
FLUSHING - After draining, flushing is desirable. Replace the drain plug and fill the transmission to the proper level with a light flushing oil. Drive the transmission for a short period at fast idle in such a manner that the gears in the transmission are rotating without load. This washes out the old oil clinging to the interior of the gear case, covers and shifter rails. **BE SURE TO DRAIN OUT ALL** of the flushing oil before attempting to refill with new oil. This flushing procedure is most important after first drain.

REFILL - First, removal all dirt around the filler plug, Then refill with new oil of a grade recommended for the existing season and prevailing service. Fill to the bottom of the level testing plug positioned on the side of the transmission. **DO NOT OVERFILL**, as the excess quantity will serve no useful purpose. If the oil level is too high, it will cause excessive oil churning and high oil temperature and possible leakage.

INSPECTION - Oil level inspection should be made every 6,000 miles [9654,0 Km] which usually coincides with the vehicle manufacturers chassis lube procedure. Always clean around filler plug before inspection. Add sufficient oil to maintain correct level.



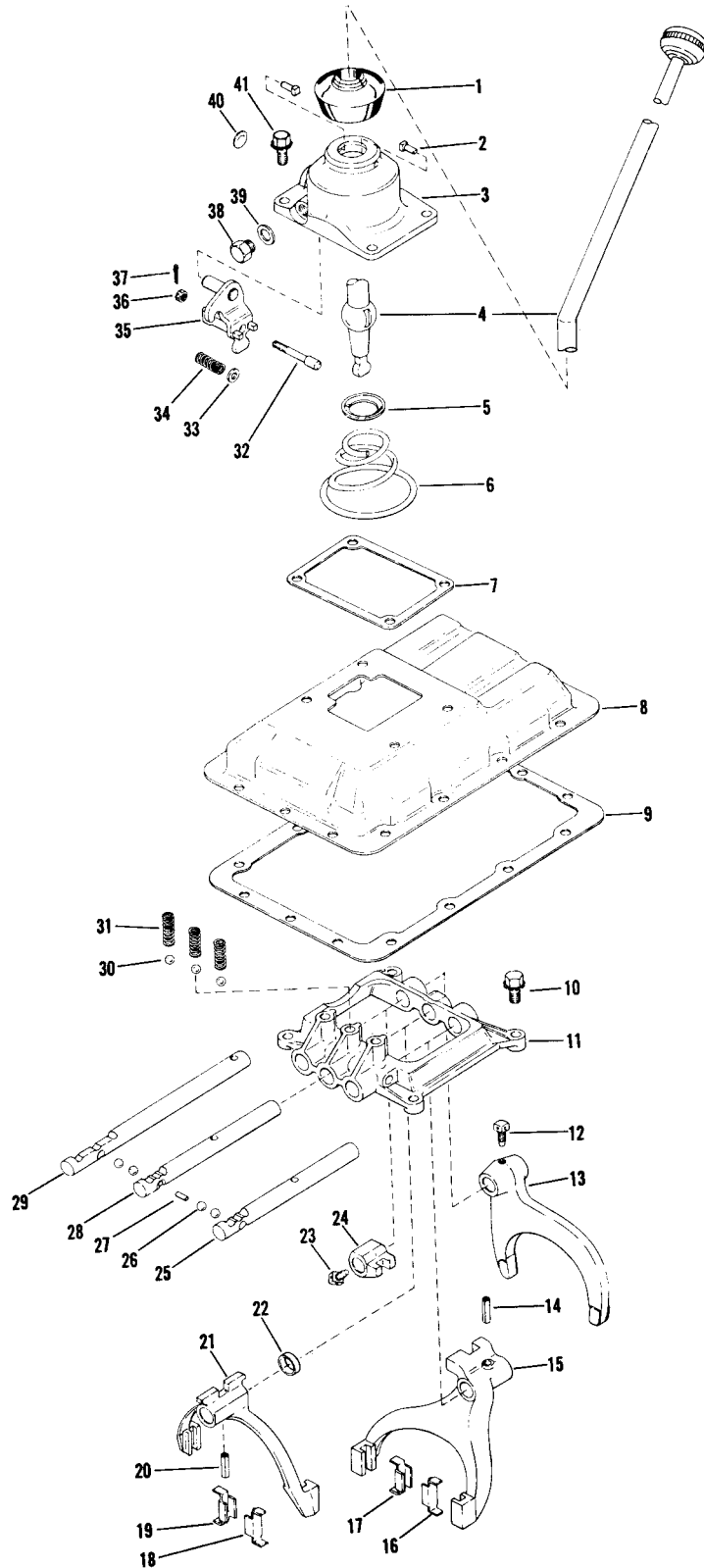
CLARK



280V-Series Transmission

Item	Description	QTY	Item	Description	QTY
1	Shift Rod Cover Screw.....	14	43	Brake Drum to Flange Bolt.....	4
2	Shift Rod Cover Screw Lockwasher.....	14	44	Mainshaft Rear Oil Seal.....	1
3	Control Cover (Stamped version).....	1	45	Mainshaft Rear Bearing capscrew.....	3
4	Control Cover Gasket.....	1	46	Mainshaft Rear Bearing capscrew Lockwasher.....	3
5	Mainshaft 5th Speed Synchronizer Cup.....	1	47	Mainshaft Rear Bearing Cap.....	1
6	Mainshaft 4th & 5th Synchronizer Assembly.....	1	48	Mainshaft Rear Bearing Cap Gasket.....	2
7	Mainshaft 4th Speed Synchronizer Cup.....	1	49	Speedometer Drive Gear.....	1
8	Mainshaft 4th & 5th Shift Hub Sleeve Retainer Ring.....	1	50	Mainshaft Rear Bearing.....	1
9	Mainshaft 4th & 5th Shift Hub Sleeve.....	1	51	Transmission Case.....	1
10	Mainshaft 4th Speed Gear.....	1	52	P.T.O. Cover Plate Gasket.....	2
11	Mainshaft 3rd Gear Retainer Ring.....	1	53	P.T.O. Cover Plate.....	2
12	Mainshaft 3rd Gear Locating Washer.....	1	54	P.T.O. Cover Plate Screw.....	12
13	Mainshaft 3rd Speed Gear.....	1	55	Mainshaft Rear Bearing capscrew Lockwasher.....	1
14	Mainshaft 3rd Speed Synchronizer Cup.....	1	56	Mainshaft Rear Bearing capscrew.....	1
15	Mainshaft 2nd & 3rd Synchronizer Assembly.....	1	57	Speedometer Driven Gear.....	1
16	Mainshaft 2nd & 3rd Shift Hub Sleeve Retainer Ring.....	1	58	Speedometer Tube Nut.....	1
17	Mainshaft 2nd & 3rd Shift Hub Sleeve.....	1	59	Reverse Idler Shaft Lock Screw.....	1
18	Mainshaft 2nd & 3rd Shift Hub Sleeve Retainer Ring.....	1	60	Reverse Idler Shaft Lock.....	1
19	Mainshaft 2nd Speed Gear.....	1	61	Reverse Idler Shaft.....	1
20	Mainshaft 2nd Speed Gear Locating Washer.....	1	62	Reverse Idler Thrust Washer.....	2
21	Mainshaft 2nd Speed Gear Retainer Ring.....	1	63	Reverse Idler Bearing.....	2
22	Mainshaft.....	1	64	Reverse Idler Gear.....	1
23	Mainshaft 1st & Reverse Gear.....	1	65	Mainshaft Spigot Bearing.....	1
24	Countershaft Rear Bearing capscrew.....	4	66	Main Drive Gear.....	1
25	Countershaft Rear Bearing Cap Lockwasher.....	4	67	Main Drive Gear Bearing Oil Slinger.....	1
26	Countershaft Rear Bearing Cap.....	1	68	Main Drive Gear Bearing.....	1
27	Countershaft Rear Bearing Cap Gasket.....	1	69	Main Drive Gear Bearing Retainer Ring.....	1
28	Countershaft Rear Bearing Cap Retainer Ring.....	1	70	Main Drive Gear Bearing Cap Oil Seal.....	1
29	Countershaft Rear Bearing.....	1	71	Main Drive Gear Bearing Cap Gasket.....	1
30	Countershaft Rear Bearing Oil Slinger.....	1	72	Main Drive Gear Bearing Cap.....	1
31	Countershaft.....	1	73	Main Drive Gear Bearing capscrew.....	4
32	Countershaft Gear Key.....	1	74	Clutch Housing Stud Nut.....	4
33	Countershaft 4th Speed Gear.....	2	75	Clutch Housing Stud Nut Lockwasher.....	4
34	Countershaft Drive Gear.....	1	76	Clutch Housing Stud.....	4
35	Countershaft Drive Gear Retainer Ring.....	1	77	Countershaft Pilot Bearing.....	1
36	Filler Plug.....	1	78	Pedal Shaft Grease Fitting.....	2
37	Magnetic Drain Plug.....	1	79	Clutch Housing Inspection Plate Bolt.....	2
38	Flange Nut.....	1	80	Clutch Housing Inspection Plate Lockwasher.....	2
39	Flange to Drum Bolt Nut.....	4	81	Clutch Housing Inspection Plate.....	1
40	Flange to Drum Bolt Lockwasher.....	4	82	Clutch Pedal Shaft Bushing.....	4
41	Companion Flange.....	1	83	Clutch Housing.....	1
42	Brake Assembly.....	1			

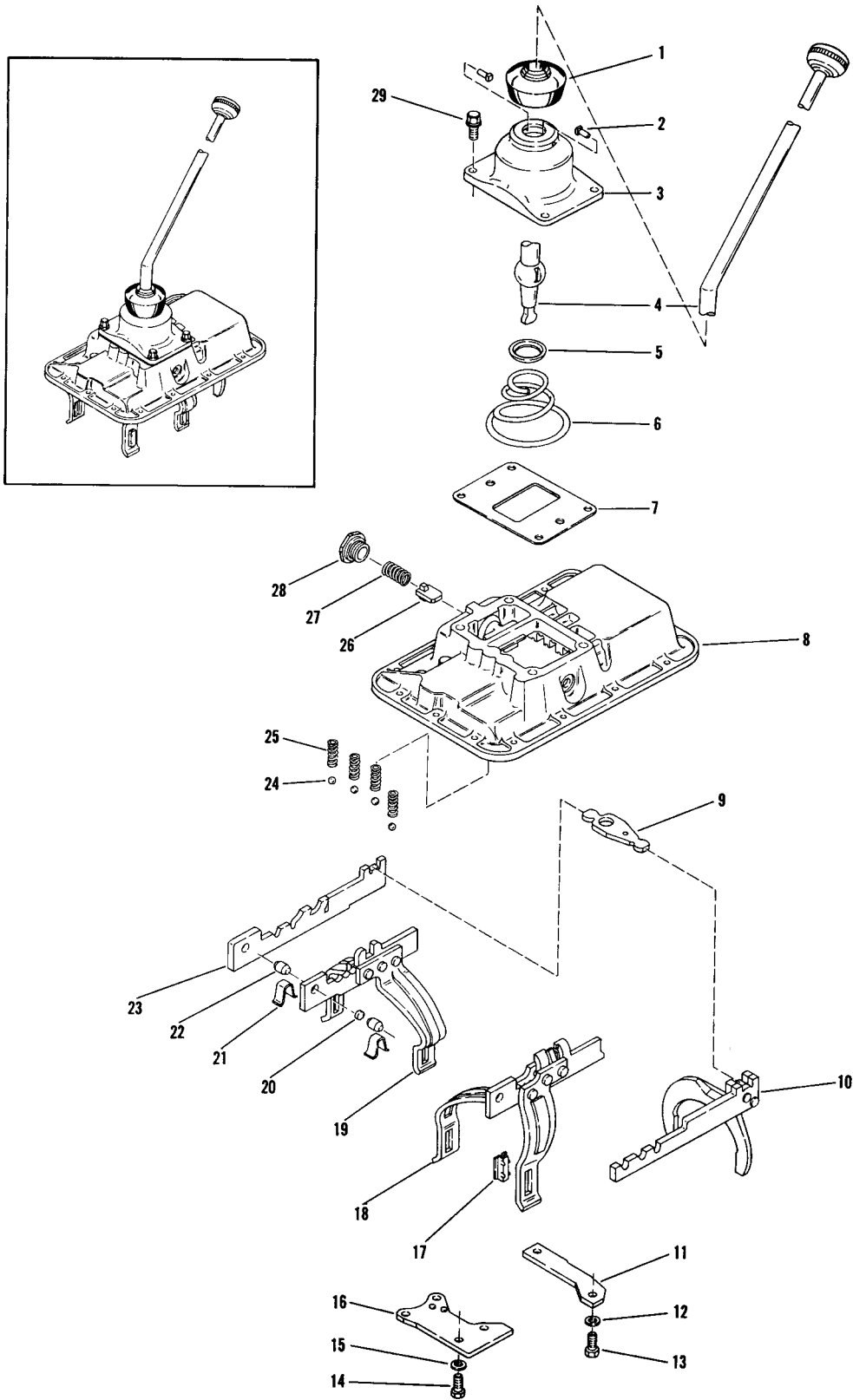
CLARK



280V-SERIES CONTROL PARTS GROUP (Stamped Cover)

ITEM	Description	QTY	ITEM	Description	QTY
1	Gear Shift Lever Dust Cover.....	1	32	Reverse Latch Plunger.....	1
2	Gear Shift Lever Pivot Pin.....	2	33	Reverse Latch Plunger Retainer Washer.....	1
3	Control Top	1	34	Reverse Latch Plunger Spring	1
4	Gear Shift Lever	1	35	1st & Reverse Rocker.....	1
5	Gear Shift Lever Support Washer.....	1	36	Reverse Latch Plunger Nut	1
6	Support Spring	1	37	Reverse Latch Plunger Nut Cotter.....	1
7	Control Top Gasket.....	1	38	Backup Switch Hole Plug.....	1
8	Shift Rod Cover.....	1	39	Backup Switch Hole Plug Gasket	1
9	Shift Rod Cover Gasket.....	1	40	Welch Plug	1
10	Shift Rod Support Screw and Lockwasher.....	4	41	Control Top Screw & Lockwasher	4
11	Shift Rod Support.....	1			
12	1st & Reverse Shift Fork Lockscrew	1			
13	1st & Reverse Shift Fork	1			
14	Shift Fork Lock Pin.....	1			
15	4th & 5th Shift Fork Assembly (Inc. Items 16 & 17)1				
16	Shift Fork Bushing	2			
17	Shift Fork Bushing	2			
18	Shift Fork Bushing	2			
19	Shift Fork Bushing	2			
20	Shift Fork Lock Pin.....	1			
21	2nd & 3rd Fork Assembly (Inc. Items 18 & 19) ...	1			
22	2nd Speed Overshift Spacer.....	1			
23	Reverse Shift Lug Lock Screw	1			
24	Reverse Shift Lug	1			
25	4th & 5th Shift Rod.....	1			
26	Mesh Lock Ball	4			
27	Interlock Cross Pin	1			
28	2nd & 3rd Shift Rod.....	1			
29	1st & Reverse Shift Rod	1			
30	Mesh Lock Spring.....	3			
31	Mesh Lock Spring.....	3			

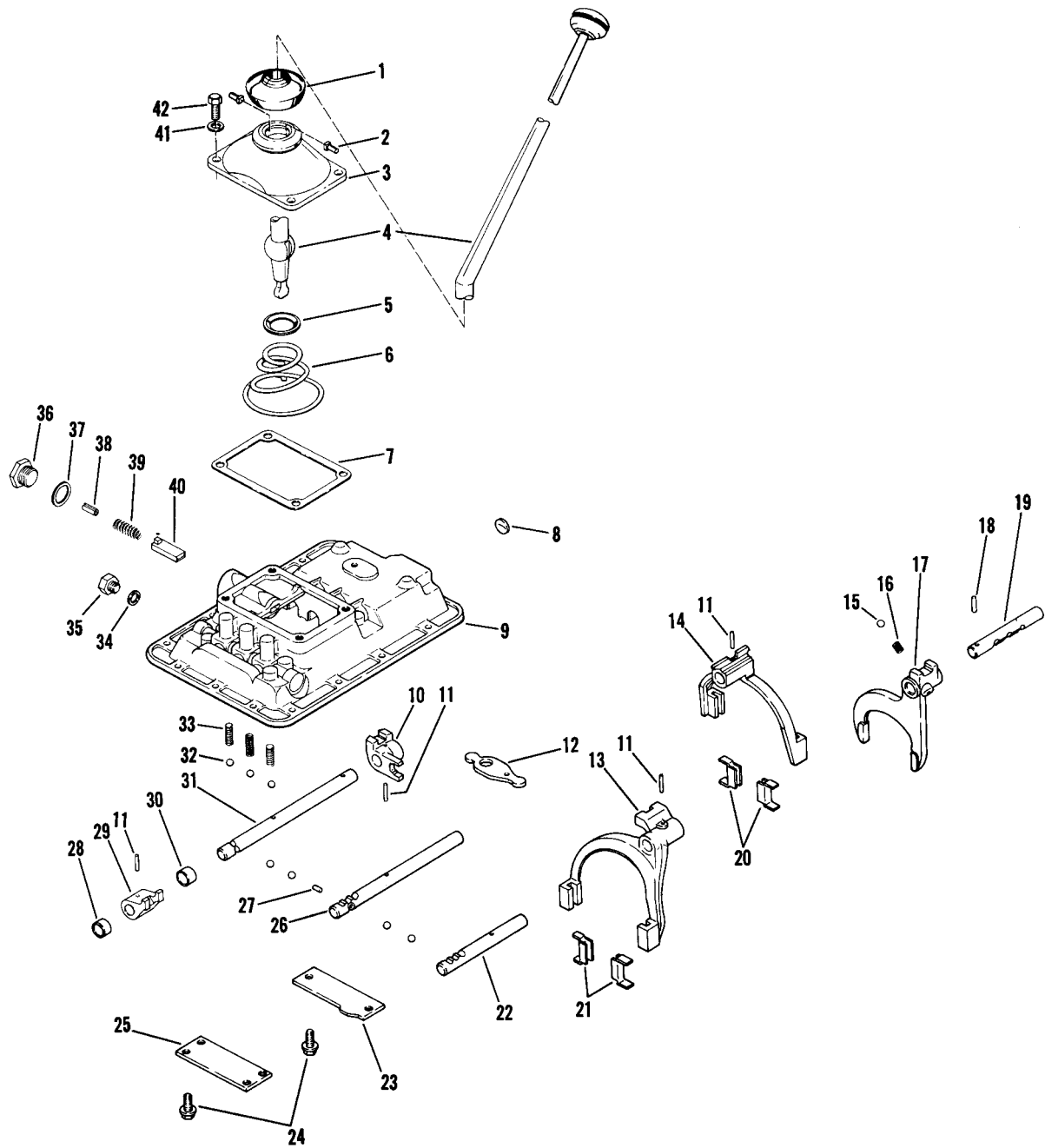
CLARK



280V-SERIES CONTROL PARTS GROUP (Diecast Cover - Fabricate Rails)

ITEM	Description	QTY	ITEM	Description	QTY
1	Gear Shift Lever Dust Cover.....	1	16	Front Rail Support.....	1
2	Gear Shift Lever Pivot Pin.....	2	17	2nd & 3rd, 4th & 5th Shift Fork Bushing.....	4
3	Control Top.....	1	18	4th & 5th Shift Fork & Rail Ass'y (Includes Item #17).....	1
4	Gear Shift Lever.....	1	19	2nd & 3rd Shift Fork & Rail Ass'y (Includes Item #17).....	1
5	Gear Shift Lever Support Washer.....	1	20	Interlock Cross Pin.....	1
6	Support Spring.....	1	21	Interlock Tapered Pin Support.....	2
7	Control Top or Remote Control Gasket.....	1	22	Interlock Tapered Pin.....	2
8	Control Cover.....	1	23	1st & Reverse Shift Rail.....	1
9	1st & Reverse Rocker Arm.....	1	24	Mesh Lock Poppet Rails.....	4
10	1st & Reverse Shift Fork & Rail Assembly.....	1	25	Poppet Springs.....	4
11	Rear Rail Support.....	1	26	Reverse Latch Plunger.....	1
12	Rear Rail Support Capscrew Lockwasher.....	2	27	Plunger Spring.....	1
13	Rear Rail Support Capscrew.....	4	28	Plunger Spring Retaining Plug.....	1
14	Front Rail Support Capscrew.....	4		Control Top or Remote Control Capscrew4	
15	Front Rail Support Capscrew Lockwasher.....	4			

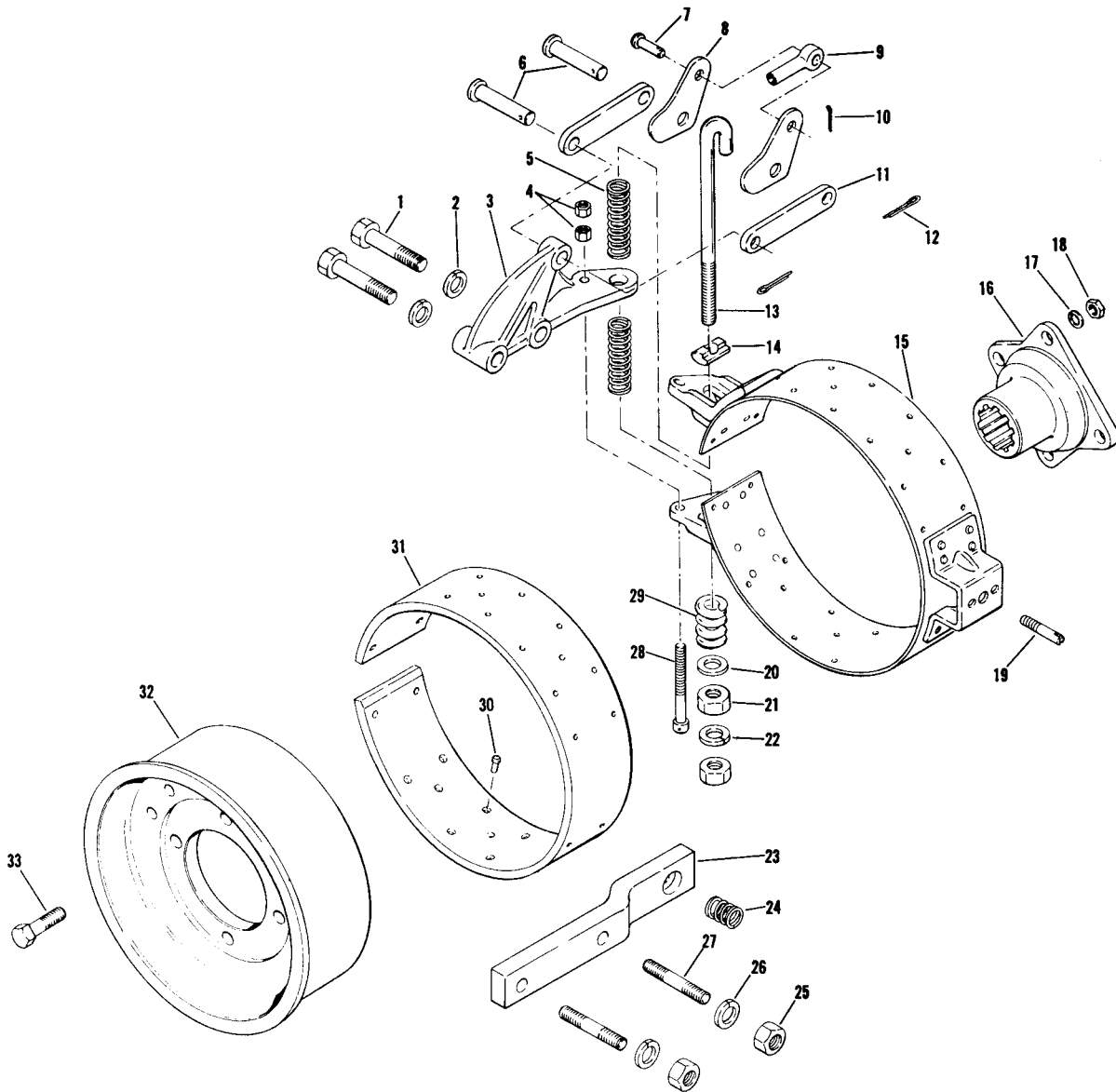
CLARK



280V-SERIES CONTROL PARTS GROUP (Diecast Cover - Round Rails)

ITEM	Description	QTY	ITEM	Description	QTY
1	Gear Shift Lever Dust Cover	1	23	Rear Rail Support	1
2	Gear Shift Lever Pivot Pin	2	24	Rail Support Screw	6
3	Control Top	1	25	Front Rail Support	1
4	Gear Shift Lever	1	26	2nd & 3rd Shift Rail	1
5	Gear Shift Lever Support Washer	1	27	Inter-Lock Cross Pin	1
6	Support Spring	1	28	1st Gear Shift Stop Space (wide)	1
7	Control Top or Remote Control Gasket	1	29	1st & Gear Shift Lug	1
8	Welch Plug	1	30	1st & Gear Shift Stop Spacer (narrow)	1
9	Shift Rail Housing	1	31	1st & Reverse Shift Rail	1
10	1st & Reverse Rocker Lug	1	32	Mesh & Inter-Lock Ball	7
11	Shift Fork Lock Pin	4	33	Mesh Lock Spring	3
12	1st & Reverse Rocker Arm	1	34	Back-up Switch Hole Plug Gasket	1
13	4th & 5th Shift Fork	1	35	Back-up Switch Hole Plug	1
14	2nd & 3rd Shift Fork	1	36	1st & Reverse Latch Plunger Springer Plug .	1
15	Mesh Lock Ball	1	37	1st & Reverse Latch Plunger Plug Gasket	1
16	1st & Reverse Mesh Lock Spring	1	38	1st & Reverse Latch Plunger Stop	1
17	1st & Reverse Shift Fork	1	39	1st & Reverse Latch Plunger Spring	1
18	1st & Reverse Shift Fork Rail Lock Pin	1	40	1st & Reverse Latch Plunger	1
19	1st & Reverse Shift Fork Rail	1	41	Control Top Lockwasher	4
20	Shift Fork Bushing	2	42	Control Top Screw	4
21	Shift Fork Bushing	2			
22	4th & 5th Shift Rail	1			

CLARK



280V-SERIES BRAKE PARTS GROUP

ITEM	Description	QTY	ITEM	Description	QTY
1	Brake Support Capscrew.....	2	18	Companion Flange to Brake Drum Bolt Nut	4
2	Brake Support Capscrew.....	2	19	Anchor Clip Screw	1
3	Brake Locating Bracket	1	20	Brake Compression Spring Washer	1
4	Brake Band Locating Screw Nut.....	2	21	Brake Adjusting Bolt Nut.....	2
5	Brake Release Spring.....	2	22	Brake Adjusting Bolt Nut Lockwasher	1
6	Brake Spacer Link Clevis Pin.....	2	23	Brake Anchor Support Bar	1
7	Brake Draw Rod Clevis Pin	1	24	Brake Anchor Clip Spring.....	1
8	Brake Cam Lever.....	2	25	Brake Support Stud Nut.....	2
9	Brake Adjusting End.....	1	26	Brake Support Stud Nut Lockwasher	2
10	Brake Draw Rod Clevis Pin Cotter	1	27	Brake Support Stud.....	1
11	Brake Spacer Link.....	2	28	Brake Band Locating Screw	1
12	Spacer Link Clevis Pin Cotter.....	2	29	Compression Spring	1
13	Adjusting Bolt	1	30	Brake Band Facing Rivet	26
14	Brake Cam Lever Shoe.....	1	31	Brake Band Facing	1 Brake Drum
15	Brake Band & Facing Assembly (Inc. items 30 & 31)	1	32	Brake Drum to Flange Bolt	4
16	Companion Flange	1			
17	Companion Flange to Brake Drum Lock- washer	4			

280V-SERIES

ASSEMBLY INSTRUCTIONS

When screws with pre-applied thread locking compound are removed after initial assembly, clean thread locking compound are removed after initial assembly, clean threads thoroughly and apply Loctite 262 Thread Lock before re-installation.

Check all mainshaft constant-mesh gears to make sure they rotate freely on mainshaft.

Check mainshaft 1st & Reverse sliding gear to make sure it slides freely on mainshaft.

Hand-spin idler gear and countershaft assemblies after each is installed on their bearings in trans. case. Both must spin freely and smoothly.

Unless otherwise specified:
Tighten all capscrews 20-25 Lbs. Ft. [27,2-33,8N.m]

Apply a thin coat of Loctite 510 Gasket Eliminator to the O.D. of all oil seals before assembly.

When screws with pre-applied thread locking compound are removed after initial assembly, clean threads thoroughly and apply Loctite 262 Thread Lock before re-installation.

Check all mainshaft constant-mesh gears to make sure they rotate freely on mainshaft.

Check mainshaft 1st & Rev. sliding gear to make sure it slides freely on mainshaft.

Hand-spin idler gear and countershaft assemblies after each is installed on their bearings in trans. case. Both must spin freely and smoothly.

Unless otherwise specified:
Tighten all capscrews 20 to 25 Lbs. Ft. [27,2-33,8N.m]

Apply a thin coat of Loctite 510 Gasket Eliminator to the O.D. of all oil seals before assembly.

Coat gasket on both sides or coat both mating surfaces with Grade #2 Multi-Purpose Grease before assembly.

Tighten 4 screws 15 to 20 Lbs. Ft. [20,4 - 27,1 N-m]

Tighten 4 screws 60 to 80 Lbs. Ft. [81,4 - 108,4 N-m]

Tighten 2 screws to maximum torque of 5 Lbs. Ft. [6,7 N-m]

These gaskets installed dry.

Tighten 4 screws 35 to 45 Lbs. Ft. [47,5 - 61,0 N-m]

Tighten 60 to 70 Lbs. Ft. [81,4 - 94,9 N-m] 4-nuts

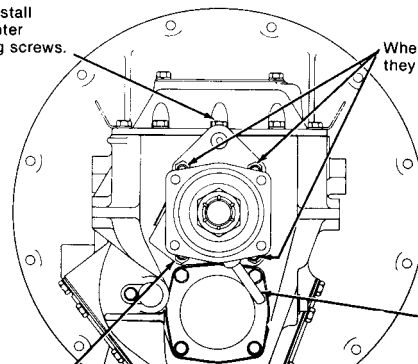
Coat gaskets on both sides or coat both mating surfaces with Grade #2 Multi-Purpose Grease.

Tighten P.T.O. cover screws - 6 each side - 10 to 15 Lbs. Ft. [13,6 - 20,3 N-m]. These screws must not be over tightened to avoid cover & gasket damage.

When installing control assembly, install & tighten center rear screw first, center front screw second & then remaining screws.

When parts list calls for only 3 studs, they should be located in these positions.

Tighten drain tube to 7-10 Lbs. Ft. [9,5 - 13,5 N-m] when required.



OVERHAUL OF TRANSMISSION ASSEMBLY

The instructions contained herein cover the disassembly and reassembly of the transmission in a sequence that would normally be followed after the unit has been removed from the machine and is to be completely overhauled.

CAUTION: Cleanliness is of extreme importance and an absolute must in the repair and overhaul of this unit. Before attempting any repairs, the exterior of the unit must be thoroughly cleaned to prevent the possibility of dirt and foreign matter entering the mechanism.

DISASSEMBLY OF THE TRANSMISSION:



Figure 1-Remove control top or remote control assembly.

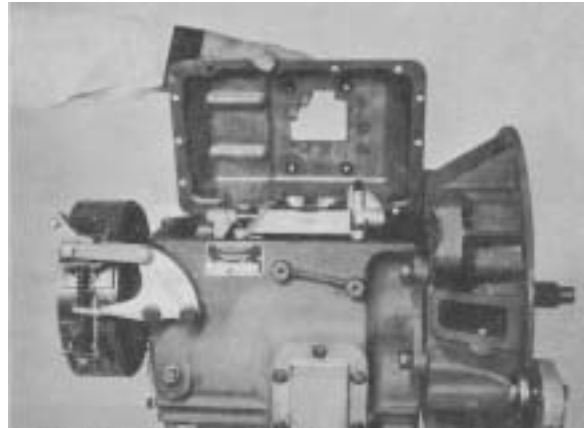


Figure 3-Remove shift rod cover.



Figure 2-Remove shift rod cover capscrews.
NOTE: See Page 23 for Diecast Cover Disassembly

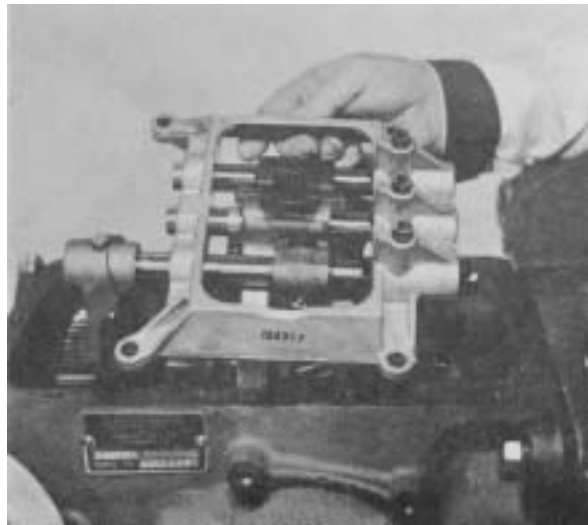


Figure 4-Remove shift rod support assembly.



Figure 5-Remove anchor clip screw lockwire and clip screw.

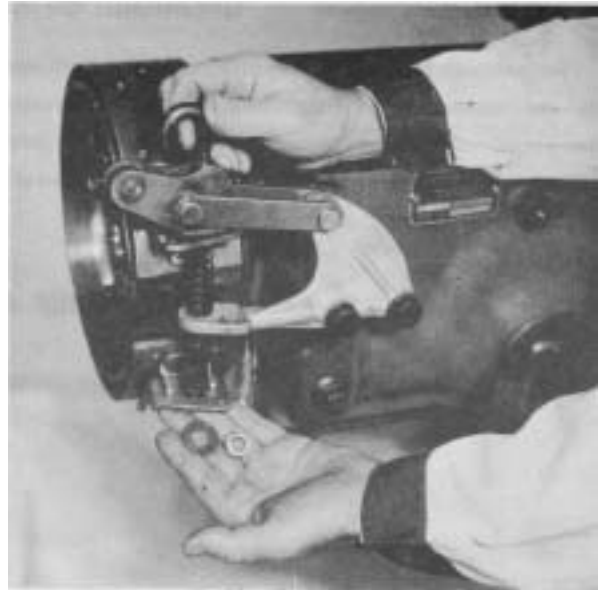


Figure 7-Remove adjusting bolt, nuts, and washer. Remove adjusting bolt.



Figure 6-Remove jam nuts and brake band locating screw.

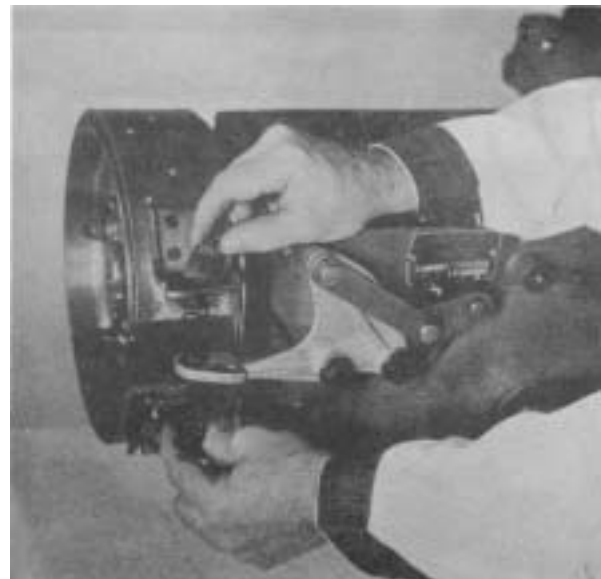


Figure 8-Remove brake release springs and cam lever shoe.

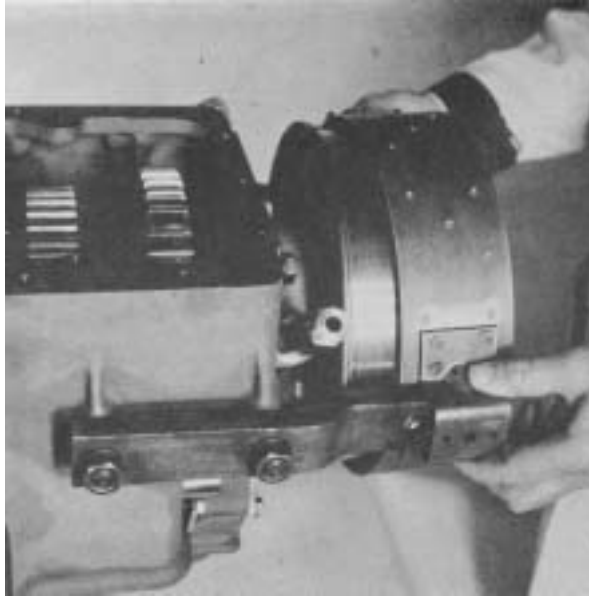


Figure 9-Remove brake band and anchor clip spring.

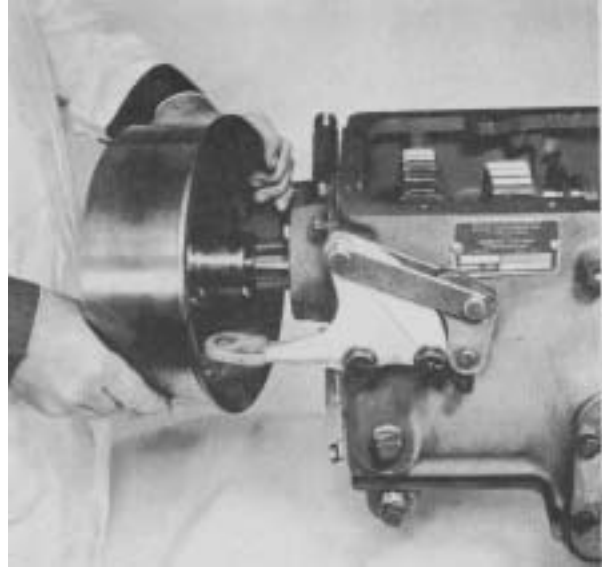


Figure 11-Remove brake drum.

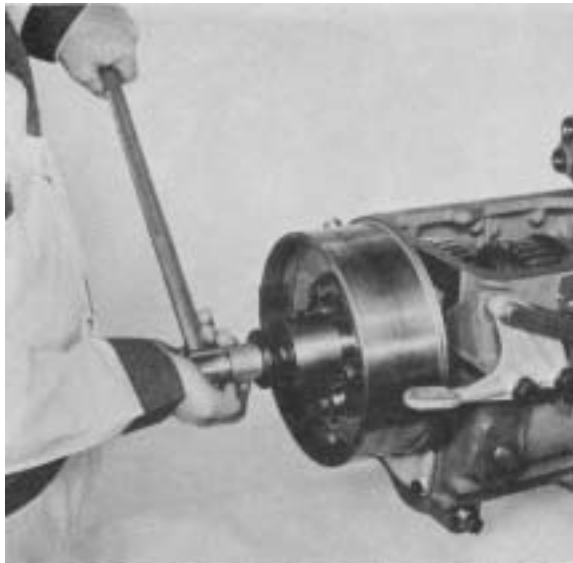


Figure 10-Lock transmission in two gears and remove brake drum.

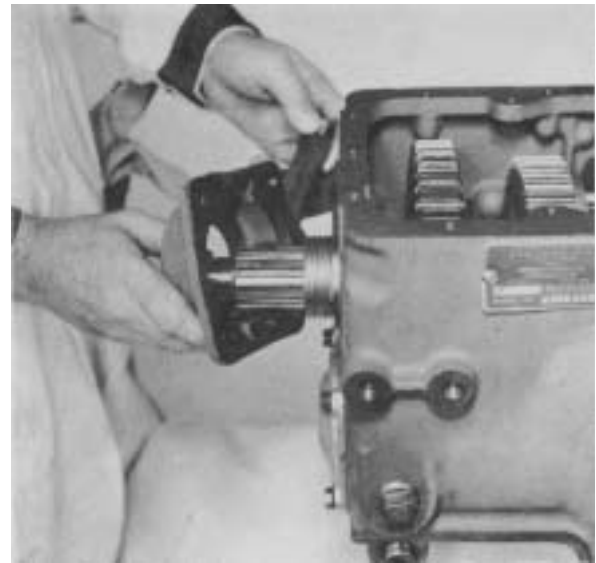


Figure 12-Remove mainshaft rear bearing cap and speedometer drive gear.

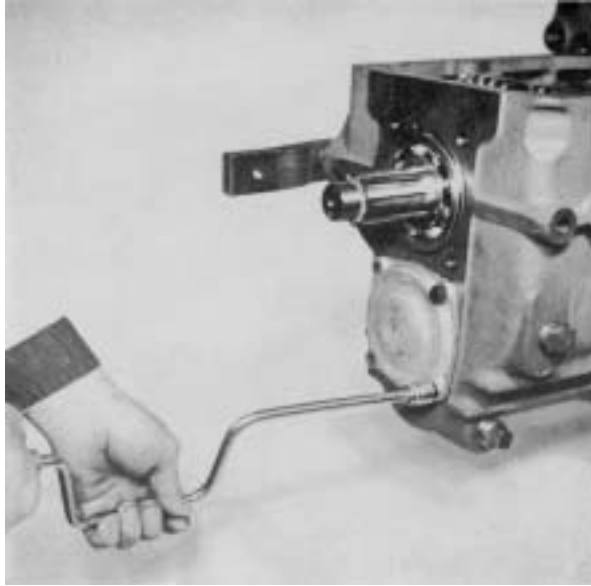


Figure 13-Remove countershaft rear bearing cap.

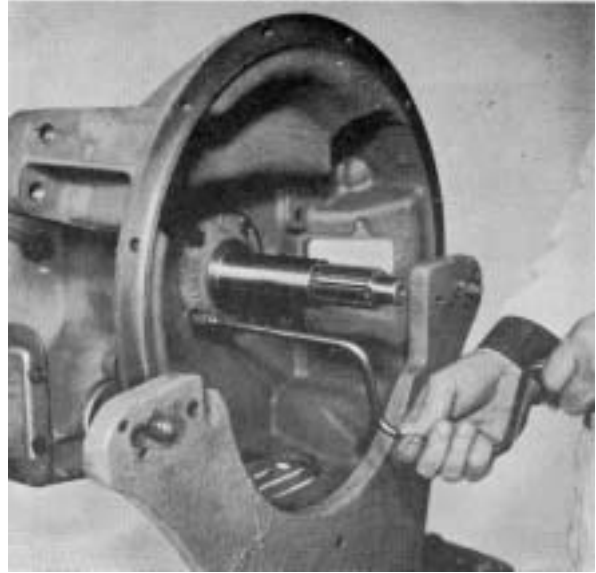


Figure 15-Remove main drive gear bearing cap.



Figure 14-Remove countershaft rear bearing retainer ring.



Figure 16-Remove main drive gear. Use caution as not to drop mainshaft spigot bearing rollers in transmission case.

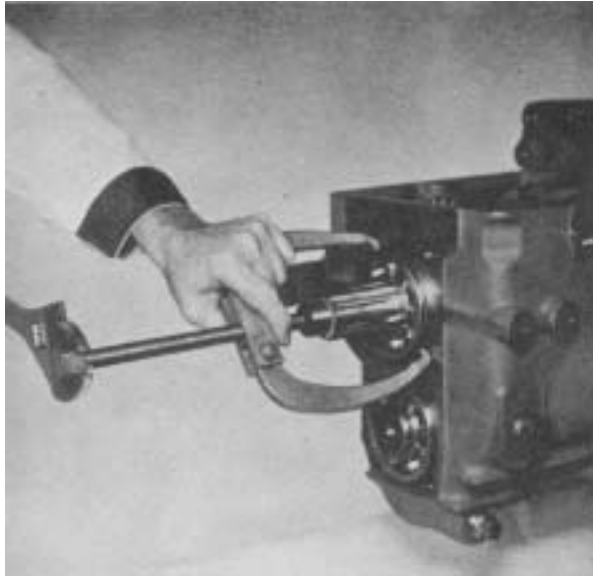


Figure 17-Pry mainshaft to the rear to expose rear bearing. Remove bearing.



Figure 19-Remove reverse idler shaft lockscrew and lock. Using a suitable puller remove reverse idler shaft.



Figure 18-Remove mainshaft assembly

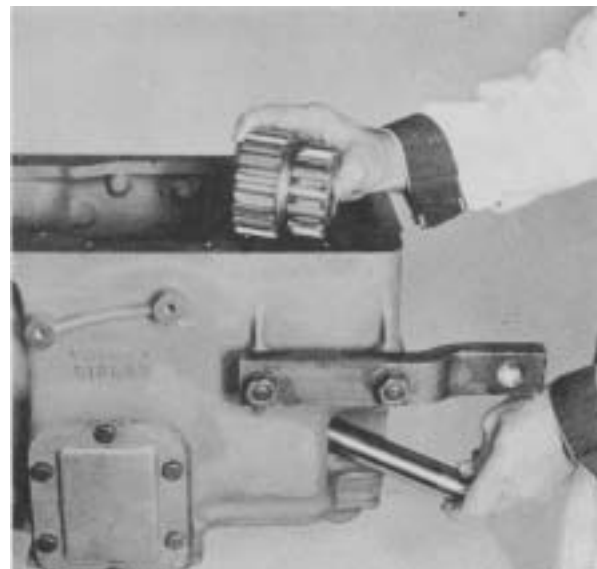


Figure 20-Remove reverse idler gear, bearings, and two thrust washers.

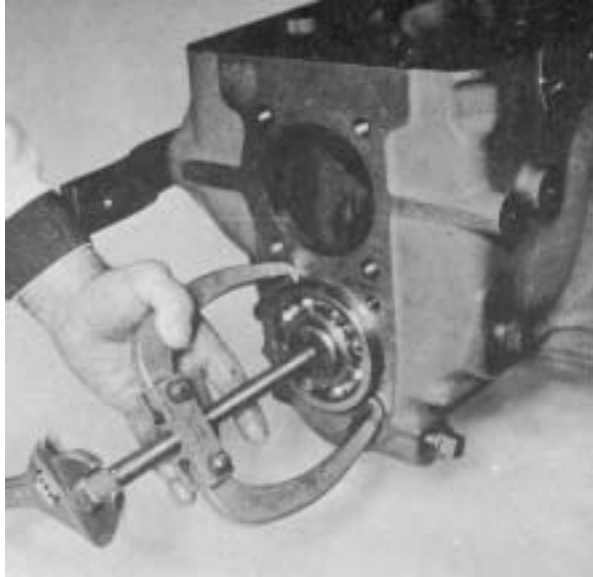


Figure 21-Pry countershaft to the rear to expose rear bearing.

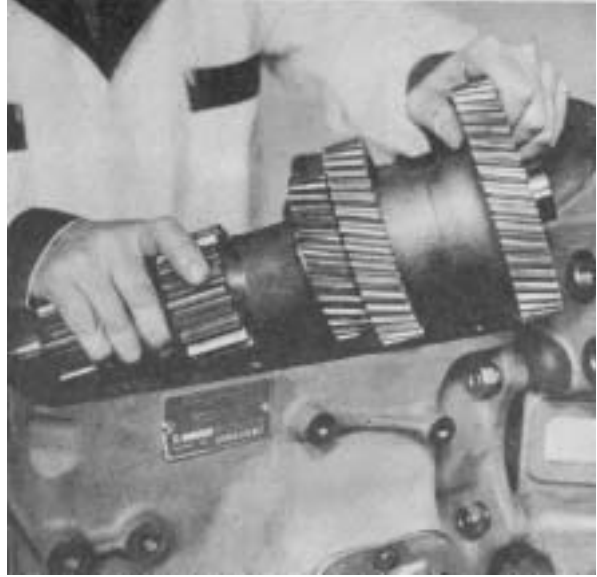


Figure 23-Remove countershaft assembly.

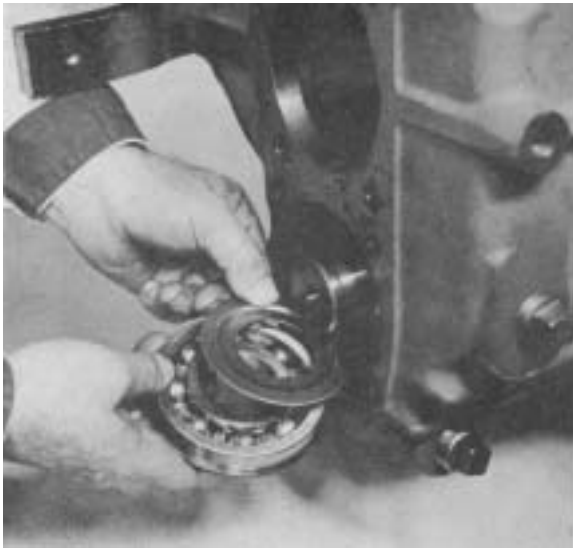


Figure 22-Remove countershaft rear bearing and oil slinger.

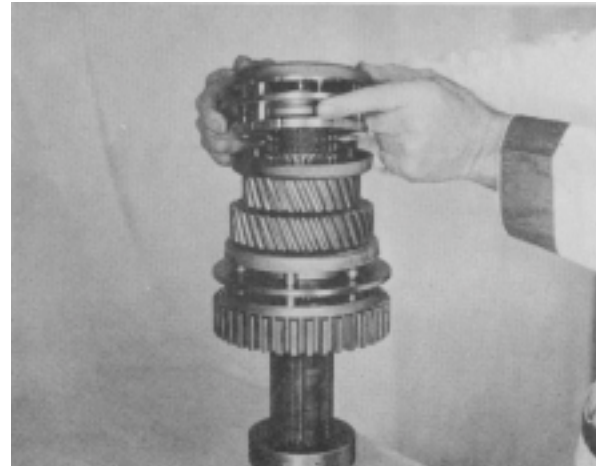


Figure 24-Remove mainshaft 1st & reverse sliding gear. Set mainshaft up as shown and remove 4th & 5th synchronizer assembly. NOTE: Bottom synchronizer cup may stay on mainshaft.



Figure 25 - Remove 4th & 5th shift hub sleeve retainer ring.

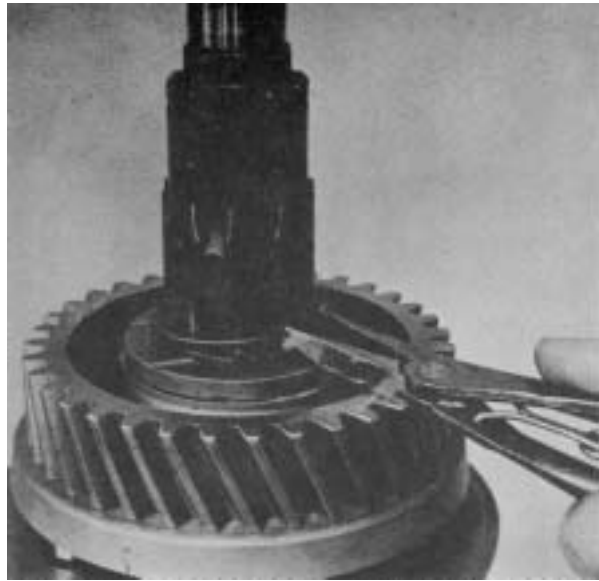


Figure 27 - Remove 3rd speed gear retainer ring.

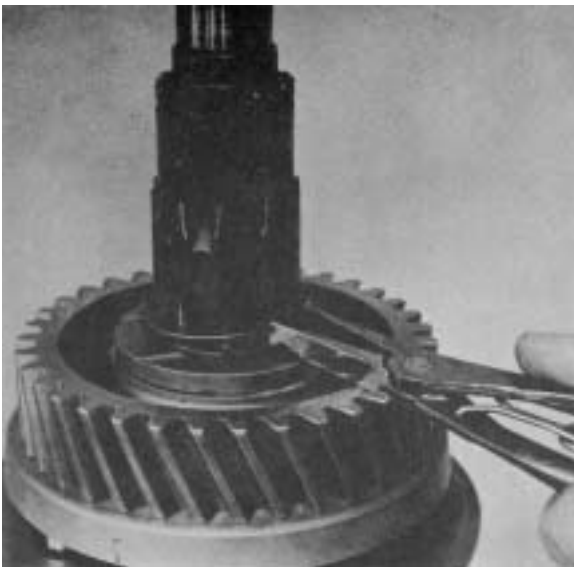


Figure 26 - Remove 4th & 5th shift hub sleeve and 4th speed gear.

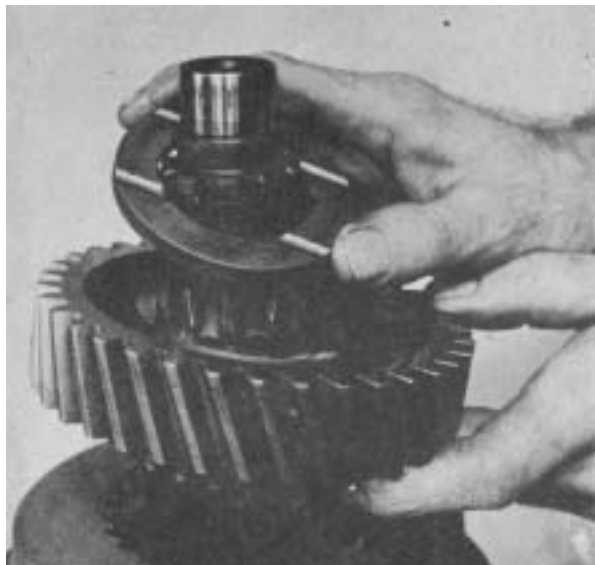


Figure 28 - Remove 3rd speed gear and locating washer.



Figure 29 - Remove 2nd & 3rd synchronizer assembly.



Figure 31 - Remove 2nd & 3rd shift hub sleeve.

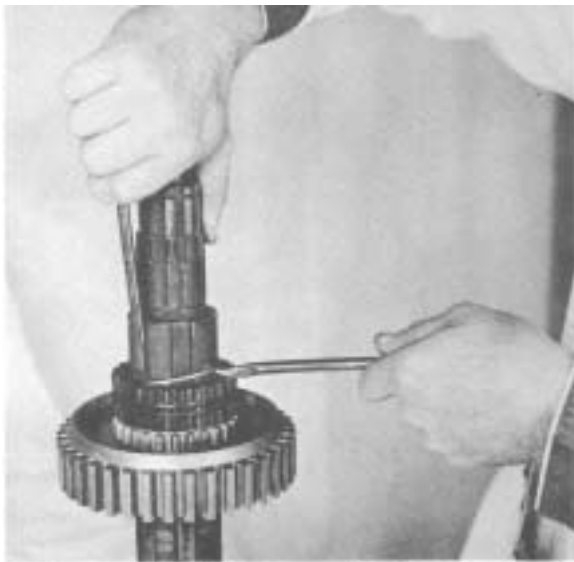


Figure 30 - Remove 2nd & 3rd shift hub sleeve retainer ring.

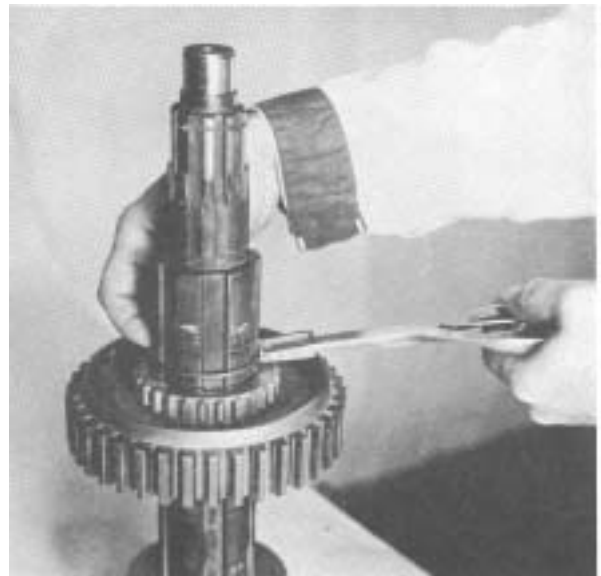


Figure 32 - Remove 2nd gear retainer ring.



Figure 33 - Remove 2nd gear and locating washer.



Figure 35 - Remove 1st & Reverse shift fork, rod and lug from shift rod support.

STAMPED CONTROL DISASSEMBLY

See Page 23 for Diecast Cover - Fabricated Rails

See Page 31 for Diecast Cover - Round Rails



Figure 34 - Remove 1st & Reverse shift lug lockscrew.

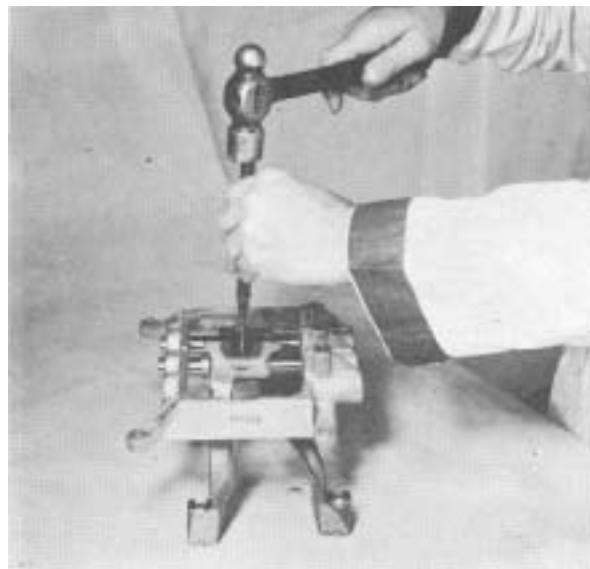


Figure 36 - Using a small pin or drift, remove 2nd & 3rd shift fork roll pin.

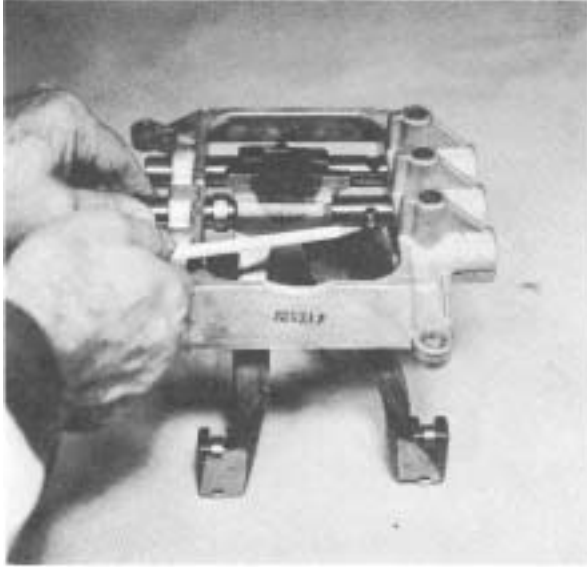


Figure 37 - Remove 2nd & 3rd shift rod. CAUTION: Do not lose interlock cross pin or 2nd speed overdrive spacer.

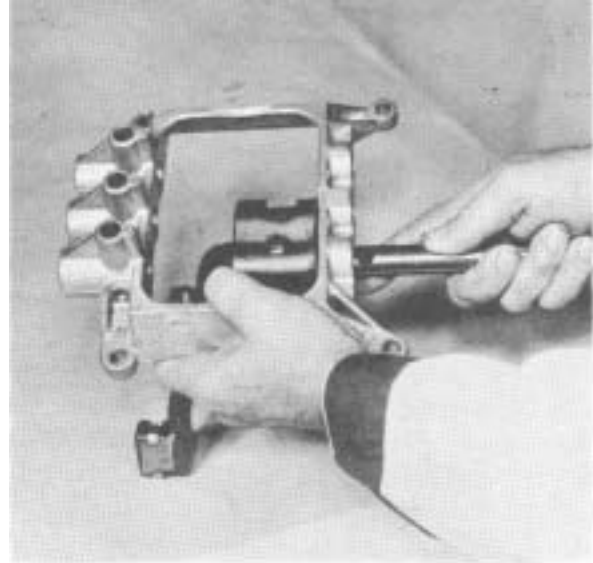


Figure 39 - Remove 4th & 5th shift rod and fork.

CLEANING AND INSPECTION

CLEANING

Cleaning all parts thoroughly using solvent type cleaning fluid. It is recommended that parts be immersed in cleaning fluid and moved up and down slowly until all old lubricant and foreign material is dissolved and parts are thoroughly cleaned.

CAUTION: Care should be exercised to avoid skin rashes, fire hazards, and inhalation of vapors when using solvent type cleaners.

Bearings:

Remove bearings from cleaning fluid and strike against a block of wood to dislodge solidified particles of lubricant. Immerse again in cleaning fluid to flush out particles. Repeat above operation until bearings are thoroughly clean. Dry bearings using moisture-free compressed air. Be careful to direct air stream across bearing to avoid spinning. Do not spin bearings when drying. Bearing say be rotated slowly by hand to facilitate drying process.

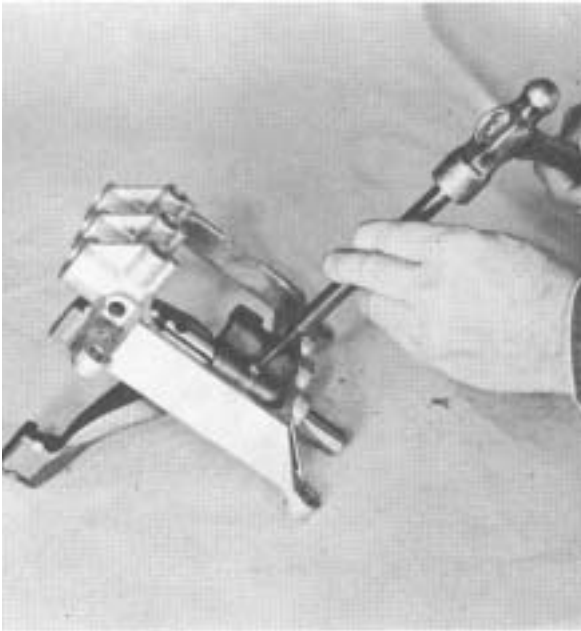


Figure 34 - Remove 4th & 5th shift fork roll pin.

Housings:

Clean interior and exterior of housings, bearing caps, etc. thoroughly. Cast parts may be cleaned in hot solution tanks with mild alkali solutions providing these parts do not have ground or polished surfaces. Parts should remain in solution long enough to be thoroughly cleaned and heated. This will aid the evaporation of the cleaning solution and rinse water. Parts cleaned in solution tanks must be thoroughly rinsed with clean water to remove all traces of alkali. Cast parts may also be cleaned with steam cleaner.

CAUTION: Care should be exercised to avoid inhalation of vapors and skin rashes when using alkali cleaners.

All parts cleaned must be thoroughly dried immediately by using moisture-free compressed air or soft, lintless absorbent wiping rags free of abrasive materials such as metal filings, contaminated oil or lapping compound.

INSPECTION

The importance of careful and thorough inspection of all parts cannot be overstressed. Replacement of all parts showing indication of wear or stress will eliminate costly and avoidable failures at a later date.

Bearings:

Carefully inspect all rollers and balls for wear, chipping or nicks to determine fitness of bearings for further use. After inspection, dip bearings in clean oil and wrap in clean lintless cloth or paper to protect them until installed.

Oil Seals, Gaskets, Etc.:

Replacement of spring load oil seals, gaskets and snap rings is more economical when unit is disassembled than premature overhaul to replace these parts at a future time. Further, loss of lubricant through a worn seal may result in failure of other more expensive parts of the assembly. Sealing members should be handled carefully, particularly when being installed. Cutting, scratching, or curling under of lip of seal seriously impairs its efficiency.

Gears and Shafts:

If magno-flux process is available, use process to check parts. Examine teeth on all gears carefully for wear, pitting, chipping, nicks, cracks, or scores. If gear teeth show spots where case hardening is worn through or cracked, replace with new gear. Small nicks may be removed with suitable hone. Inspect shafts to make certain they are not sprung, bent, or splines twisted, and that shaft are true.

Housing, Covers, Etc.:

Inspect housings, covers, and bearing caps to be certain they are thoroughly cleaned and that mating surfaces, bearing bores, etc., are free from nicks or burrs. Check all parts carefully for evidence of cracks or condition which would cause subsequent oil leaks or failures.

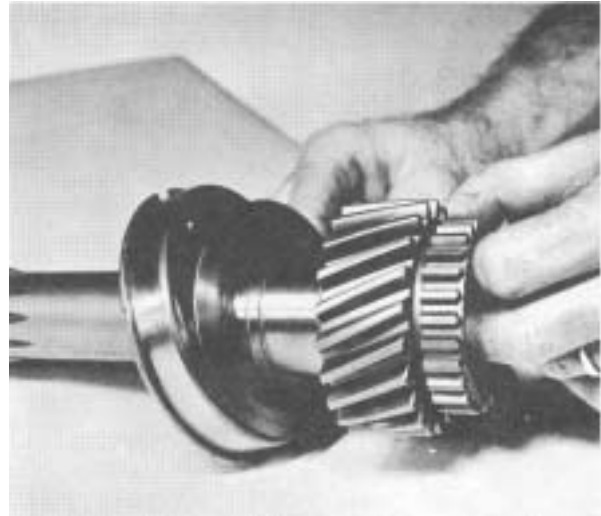
MAIN DRIVE GEAR DISASSEMBLY AND REASSEMBLY

Figure 40 - Remove main drive gear bearing retainer ring. Press bearing and oil slinger from main drive gear. Replace gear or bearing and install as shown. Install retainer ring.

CLUTCH HOUSING OR COUNTERSHAFT FRONT BEARING REPLACEMENT

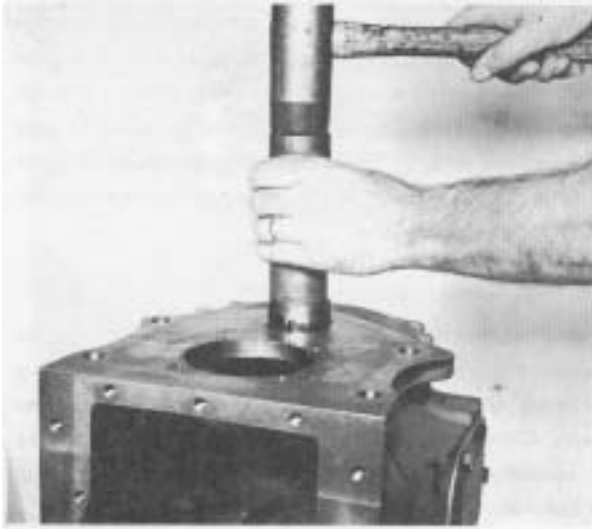


Figure 41 - If countershaft front bearing is to be replaced, remove clutch housing and drive front bearing from transmission case. Apply a light coat of permatex No. 2 on the outer diameter of the new bearing. Install in transmission case as shown with end of bearing .001 to .007 below the face of case. Install main drive gear andearing assembly in transmission case. Install main drive gear bearing cap on drive gear.

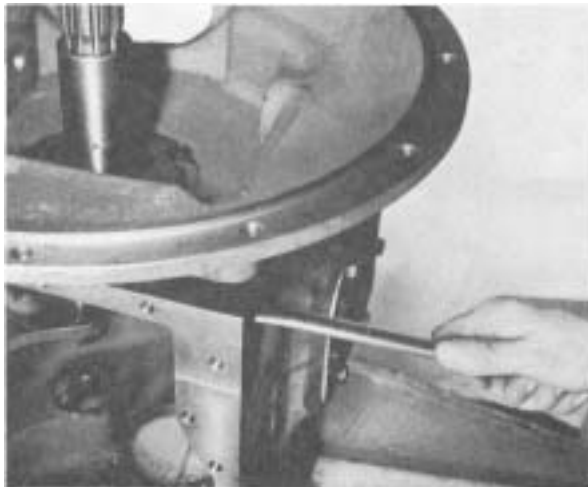


Figure 42 - Install clutch housing and tighten stud nuts 60 to 80 ft. lbs. torque. Remove drive gear bearing cap and main drive gear.

STAMPED CONTROL REASSEMBLY

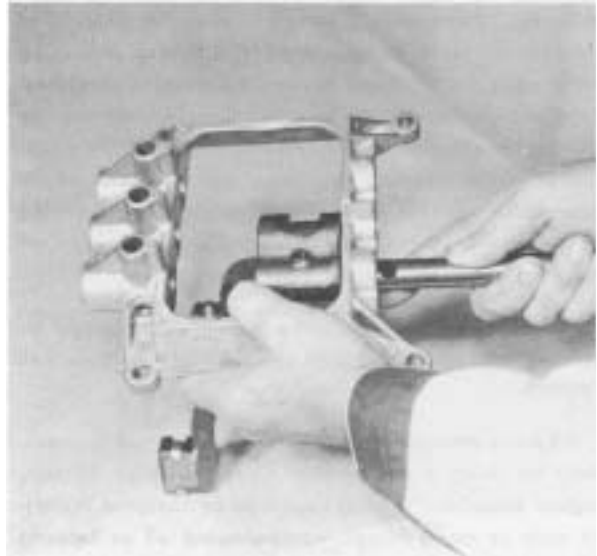


Figure 43 - Install 4th & 5th shift rod through support and into 4th & 5th shift fork.

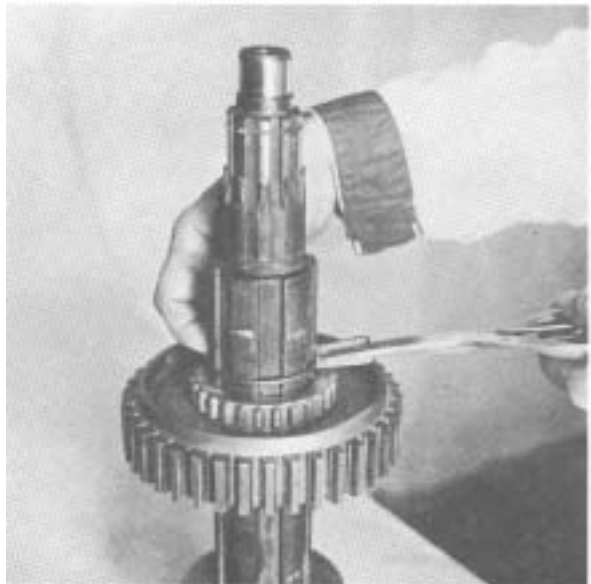


Figure 44 - Install 4th & 5th shift fork to shift rod roll pin, move rod to neutral.

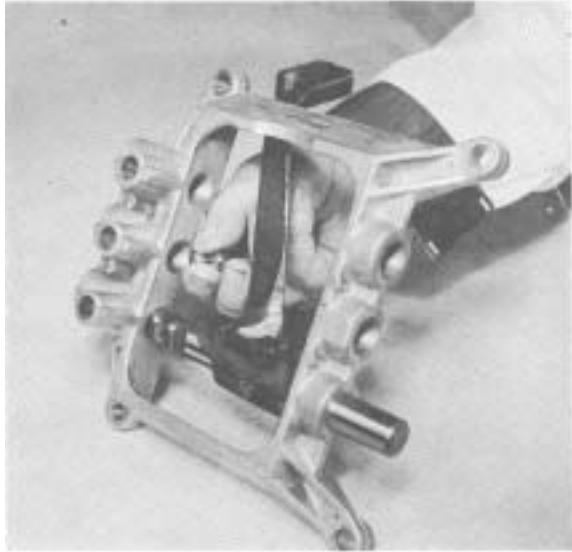


Figure 45 - Install two interlock balls between 4th & 5th, and 2nd & 3rd shift rods.

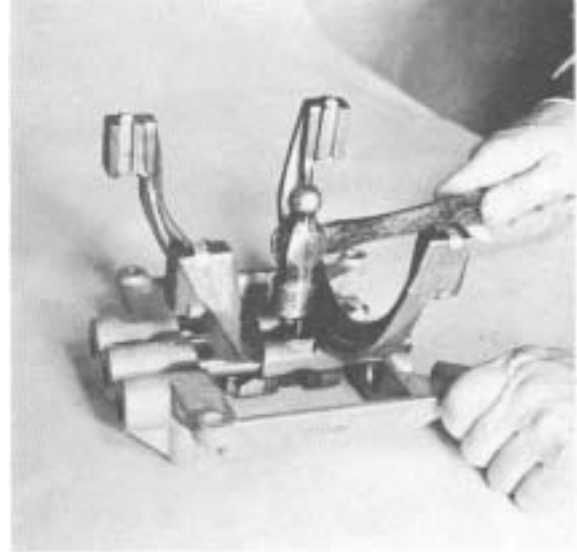


Figure 47 - Install 2nd & 3rd shift fork to shift rod roll pin. Move rod to neutral.

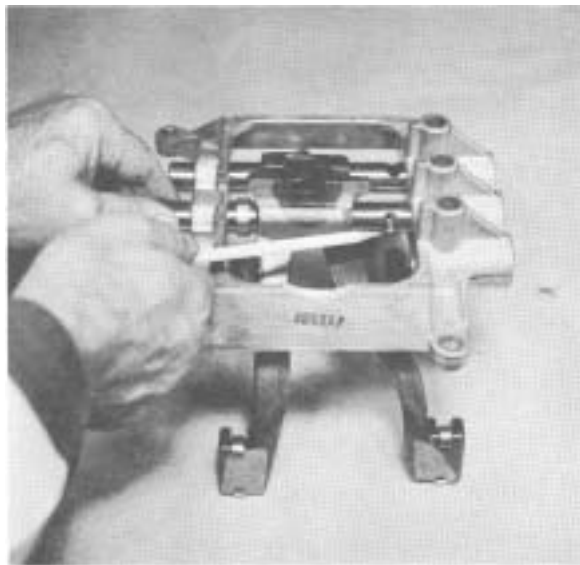


Figure 46 - Install 2nd & 3rd shift rod through shift support. Install over shift spacer, shift fork and interlock cross pin.

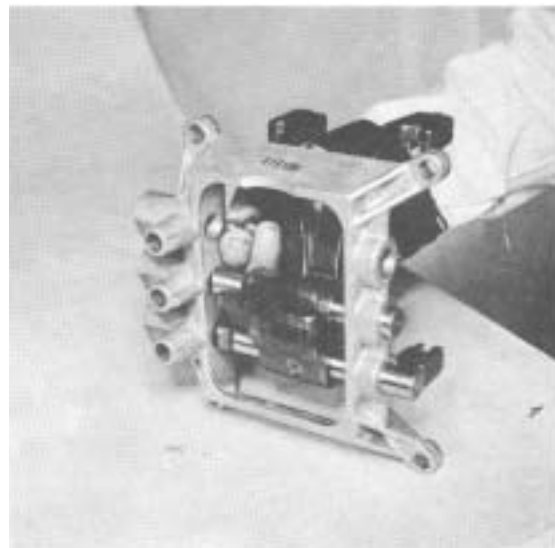


Figure 48 - Install two interlock balls between the 2nd & 3rd, and 1st & Reverse shift rods.

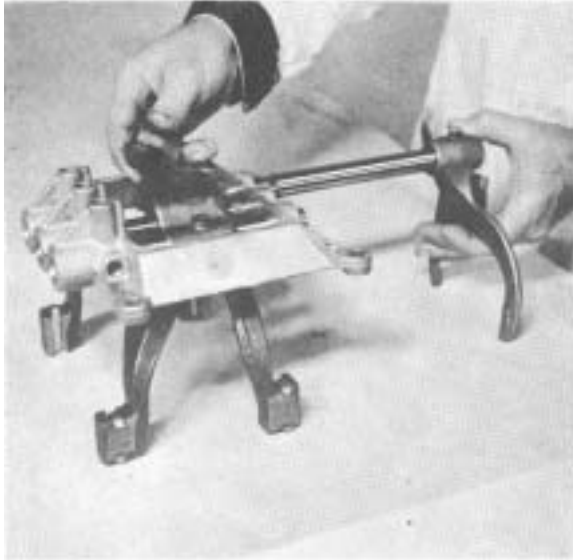


Figure 49 - Install 1st & reverse rod through support and into lug

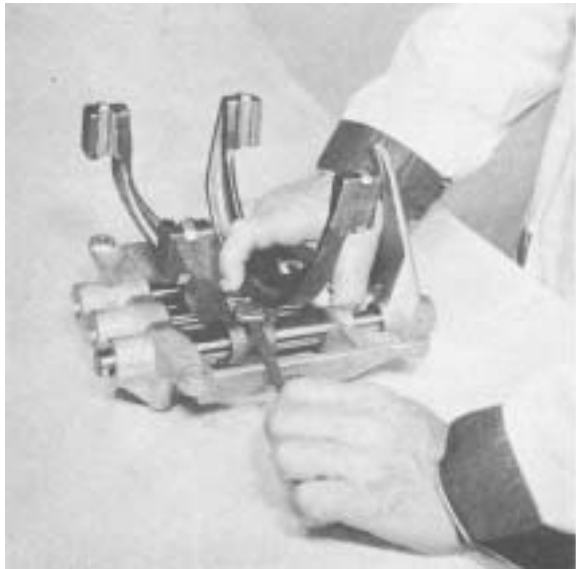


Figure 50 - Install 1st & reverse lug lockscrew and lockwire to prevent loosening.

MAINSHAFT REASSEMBLY

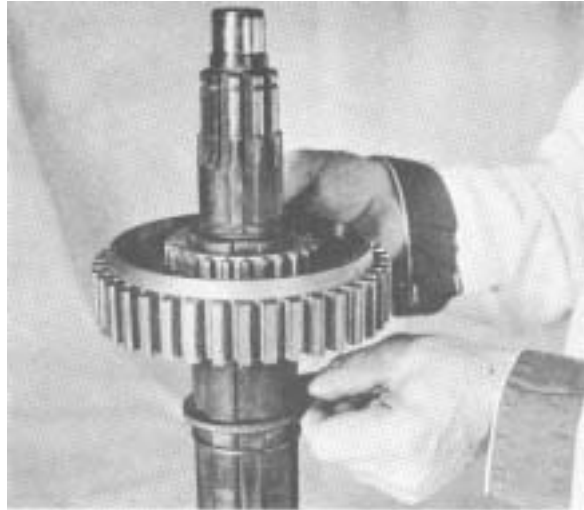


Figure 51 - Install 2nd speed gear retainer ring, locating washer, and 2nd speed gear on mainshaft. (NOTE: clutching teeth are up.)

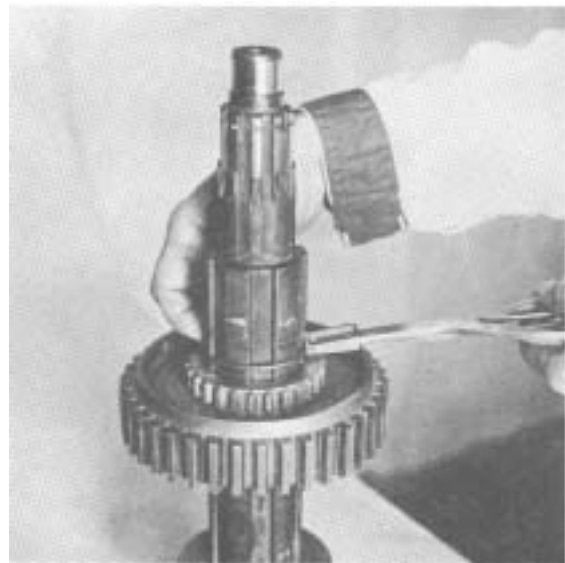


Figure 52 - Install 2nd gear retainer ring.

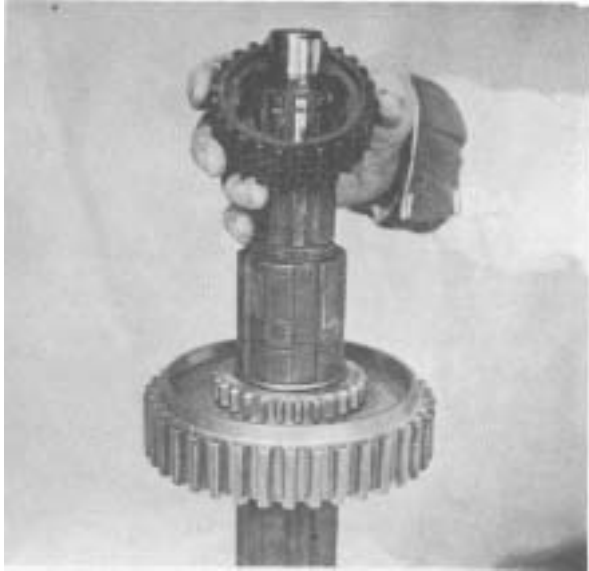


Figure 53 - Install 2nd & 3rd shift hub sleeve and sleeve retainers ring.

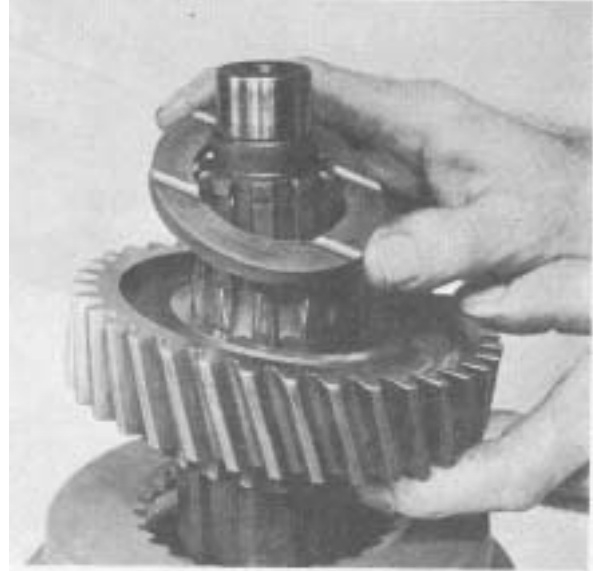


Figure 55 - Install 3rd speed gear with clutching teeth down. Install 3rd gear locating washer.



Figure 54 - Install 2nd & 3rd synchronizer assembly.



Figure 52 - Install 3rd gear retainers ring.



Figure 57 - Install 4th gear with clutching teeth up. Note chamfer on 4th & 5th shift hub sleeve. Chamfer must go down. Install bottom cup of 4th & 5th synchronizer on 4th speed gear clutching teeth before installing 4th & 5th shift hub sleeve. Install sleeve retainer ring.



Figure 59 - Turn mainshaft assembly over and install 1st & reverse sliding gear with shift fork slot down.

REASSEMBLY OF TRANSMISSION



Figure 58 - Install 4th & 5th synchronizer on shift hub sleeve.

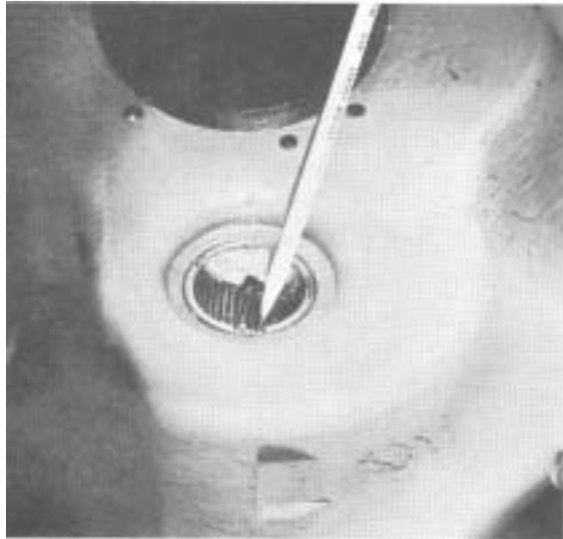


Figure 60 - Coat countershaft pilot bearing needles with heavy grease to hold in place until countershaft is installed.

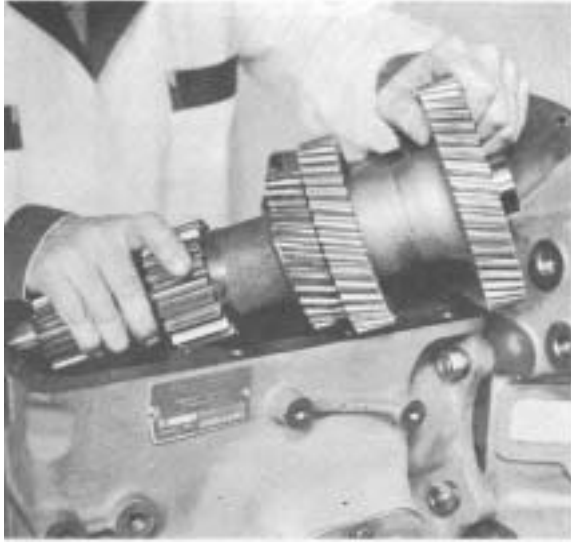


Figure 61 - Tip rear of countershaft down and into transmission case. Feed rear of countershaft through rear countershaft bearing bore. Move countershaft forward and into pilot bearing. CAUTION: Do not disrupt countershaft needle bearing.



Figure 63 - Drive rear bearing on countershaft and rear bearing bore. NOTE: Countershaft drive gear must be supported on each side with a 1/4" flat bar to prevent damage to countershaft pilot bearing.

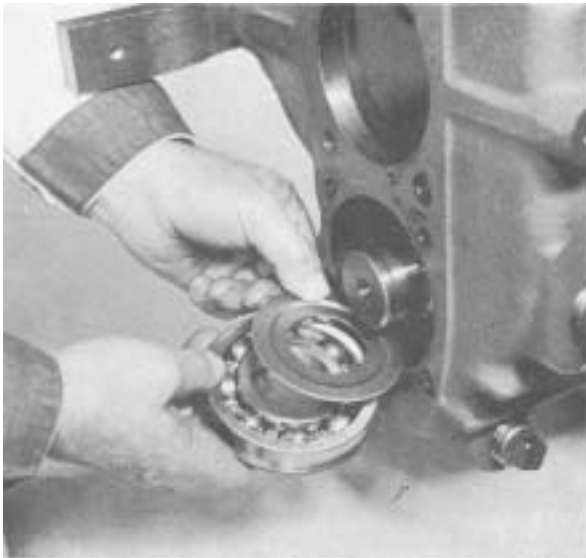


Figure 62 - Position rear bearing oil slinger as shown and start rear bearing.



Figure 64 - Install countershaft rear bearing retainer ring.



Figure 65 - Coat a new gasket on both sides with a grade #2 multi-purpose grease. Position

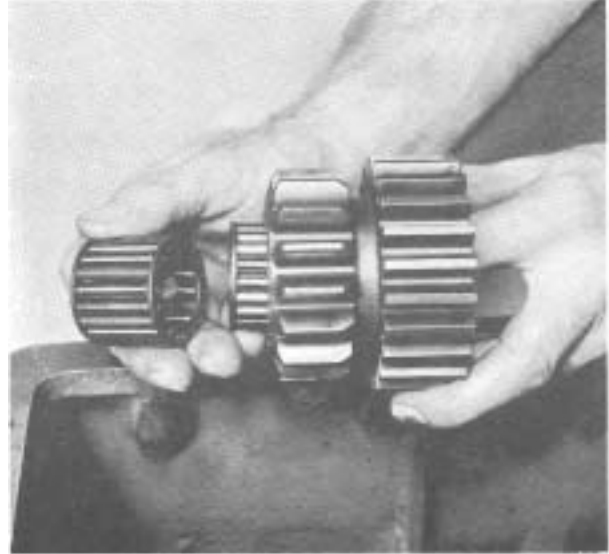


Figure 67 - Insert two reverse idler gear bearings in idler gear.

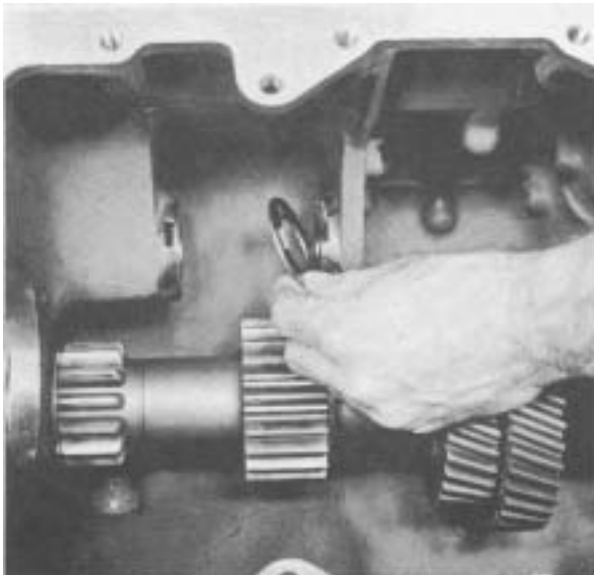


Figure 66 - Use heavy grease on reverse idler thrust washers to hold in place.

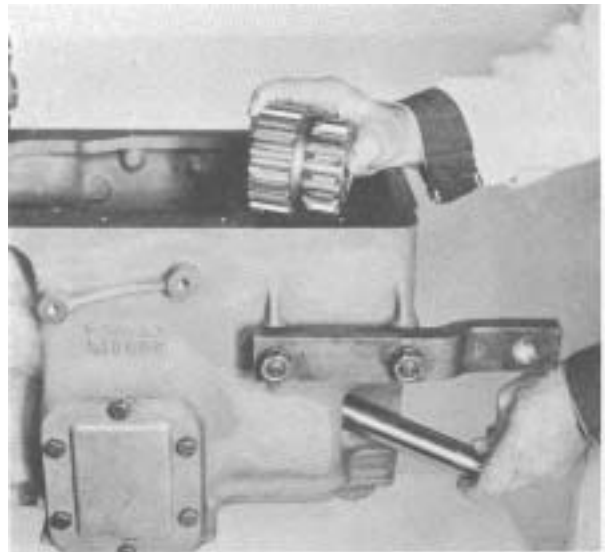


Figure 68 - Install reverse idler gear as shown. Insert idler shaft through case and idler gear. **NOTE:** Idler shaft lock groove must line up with lock bolt hole. Drive shaft into position. Install shaft lock and bolt. Tighten bolt 20 to 25 ft. lbs. torque [27,2 - 33,8 N.m].



Figure 69 - Install mainshaft assembly into transmission case as shown.

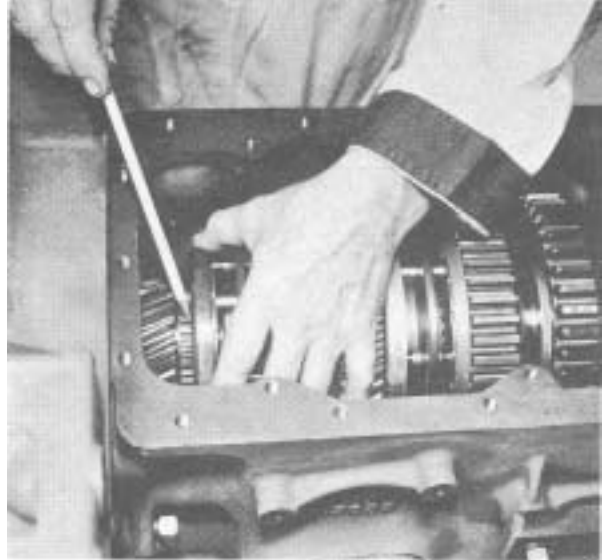


Figure 71 - Install main drive gear assembly in transmission case. Clutching teeth on main drive gear must enter 5th speed synchronizer cup without binding.



Figure 70 - Assemble the pilot bearing in the main drive gear as follows:

1. If a new pilot bearing is used it comes from the factory with a plastic sleeve. Stand drive gear on end. Set bearing and sleeve over bearing pocket in drive gear. Slide bearing rollers and cage from plastic sleeve into bearing pocket.
2. If old pilot bearing is used, set rollers in bearing cage and hold in place with a rubber band. Slide bearing rollers and cage from rubber band into bearing pocket.

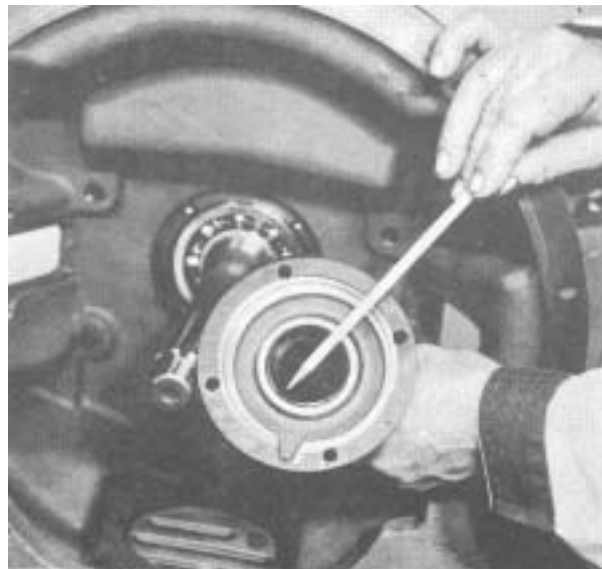


Figure 72- Press oil seal into drive gear bearing cap with lip of seal up. Coat a new gasket on both sides with a grade #2 multi-purpose grease. Position gasket on drive gear bearing cap. Use caution as not to cover oil return groove in bearing cap.

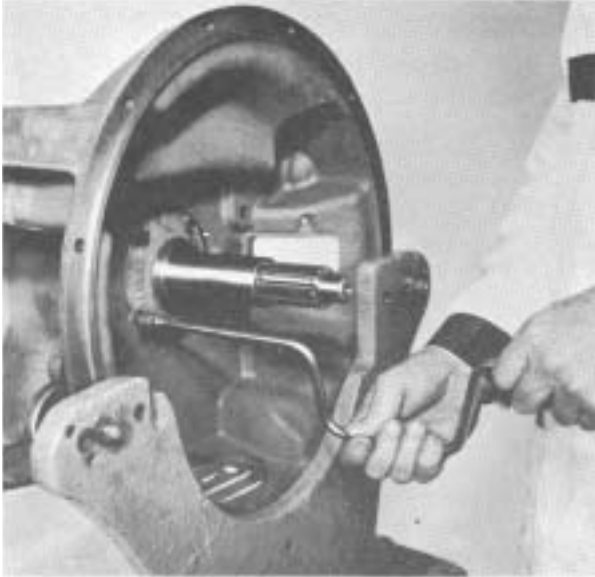


Figure 73 - With bearing cap oil return groove lined up with oil hole in transmission case, install bearing cap and bolts. Tighten bolts 15 to 20 ft. lbs. torque [20,4 - 27,1 N,m]

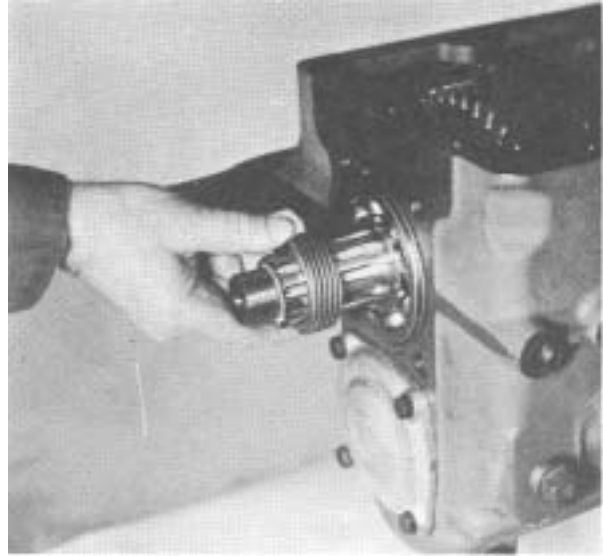


Figure 75 - Install speedometer drive gear.

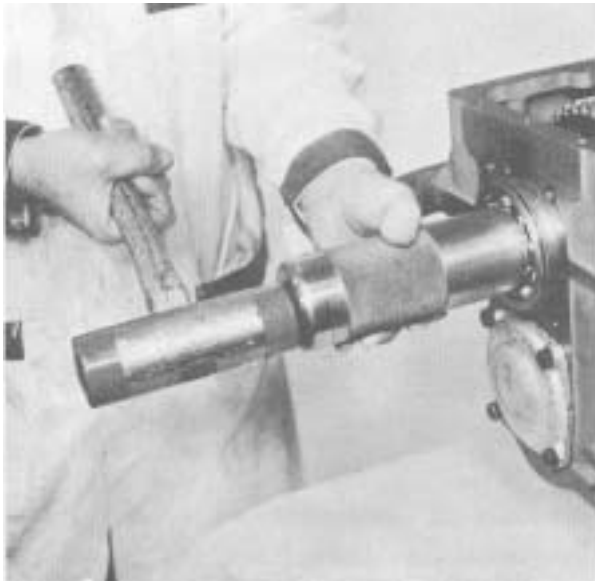


Figure 74 - Install mainshaft rear bearing.



Figure 76 - Press a new oil seal in mainshaft rear bearing cap with lip of seal down. Coat a new gasket on both sides with a grade #2 multi-purpose grease. Position gasket on mainshaft rear bearing cap, use caution as not to cover oil return grooves in bearing cap. Install bearing cap with oil grooves lined up with oil holes in case. Tighten bolts 35 to 45 ft. lbs. torque [47,5 - 61,0 N,m].

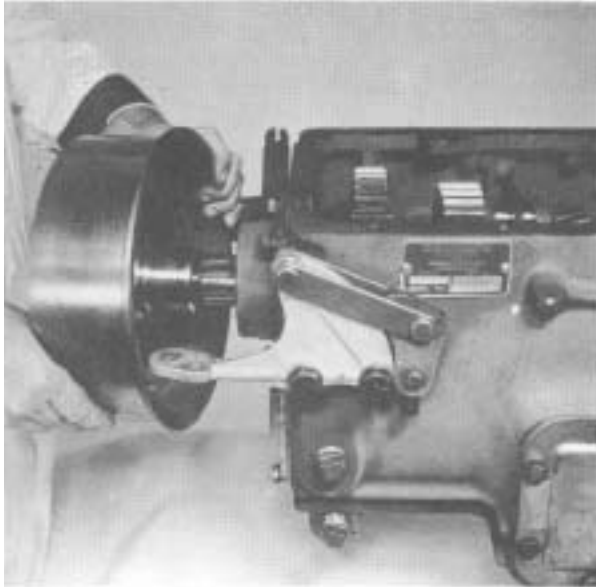


Figure 77 - Install drum and flange assembly, brake locating bracket, and anchor support bar.

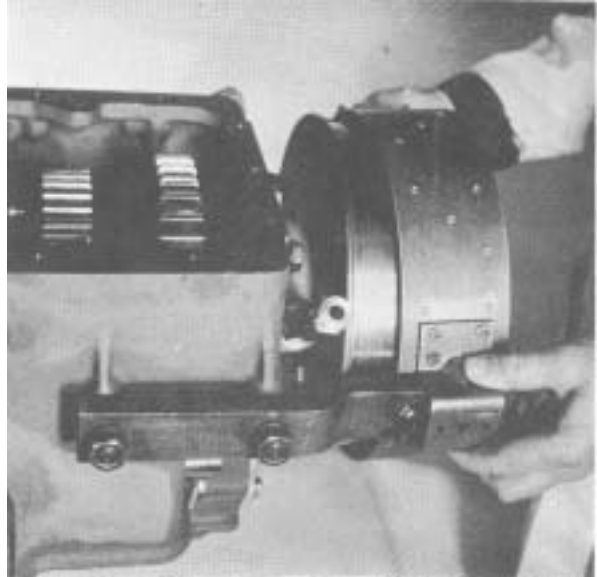


Figure 79 - Install anchor clip spring and brake band on anchor support bar.

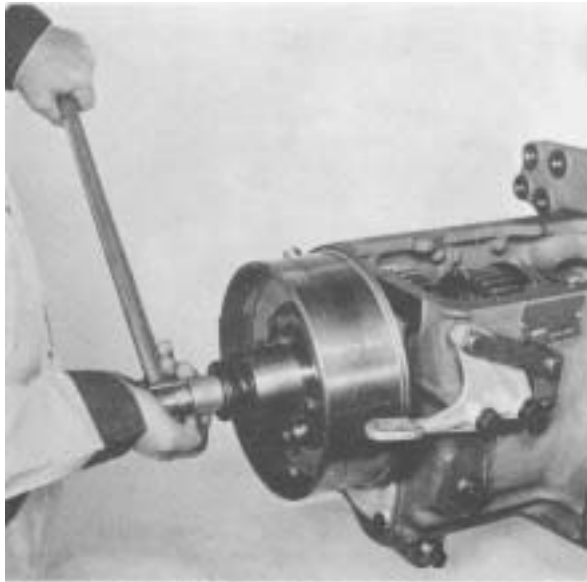


Figure 78 - Install companion flange nut and tighten 400 to 500 ft. lbs. torque [542,3 - 610,0 N,m].



Figure 80 - Install brake release springs and cam lever shoe as shown.



Figure 81 - With spacer link and cam lever in position, install adjusting bolt washer and nut.



Figure 82 - Install band locating screw as shown with threaded end up; install nut.

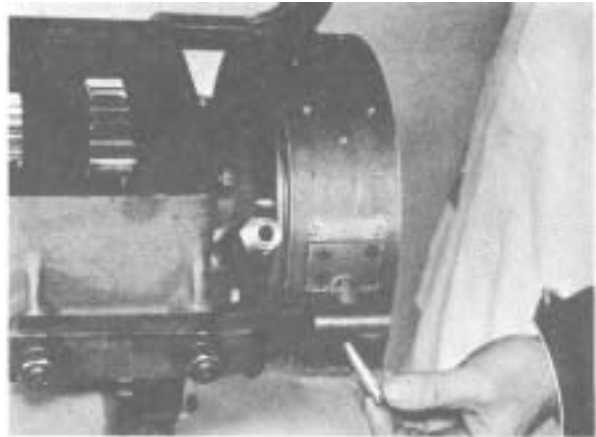


Figure 83 - Install anchor clip screw.

BRAKE BAND ADJUSTMENT

Adjust brake band anchor screw to give clearance of .010 between brake drum and band. Adjust brake band locating screw and adjusting bolt to give a .010 clearance around the entire drum. After adjustment, lockwire anchor clip screw.

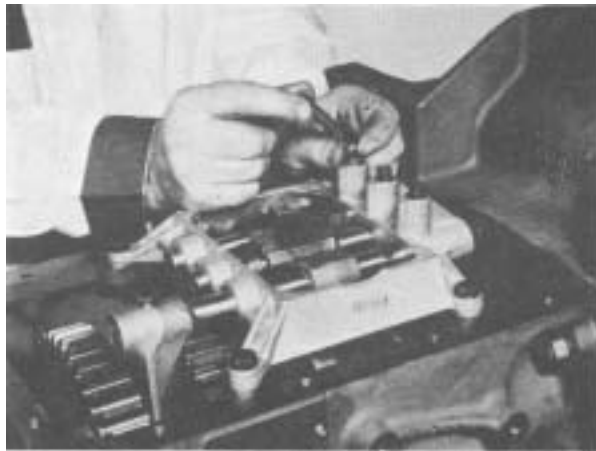


Figure 84 - With transmission shifted into neutral, install shift control assembly. 2nd & 3rd and 4th & 5th shift forks set over shift hubs, 1st & reverse fork enters slot on 1st & reverse gear. Tighten bolts 20 to 25 ft. lbs. torque [27,2 - 33,8 N.m]. Position three mesh lock balls and springs in support housing.

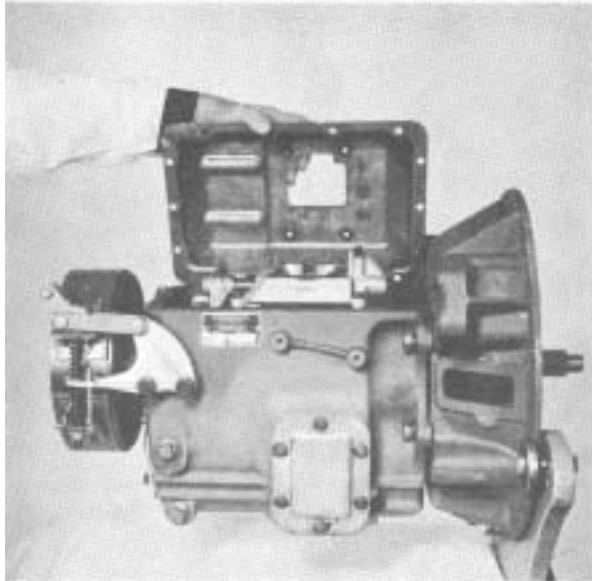


Figure 85 - Install shift support cover.

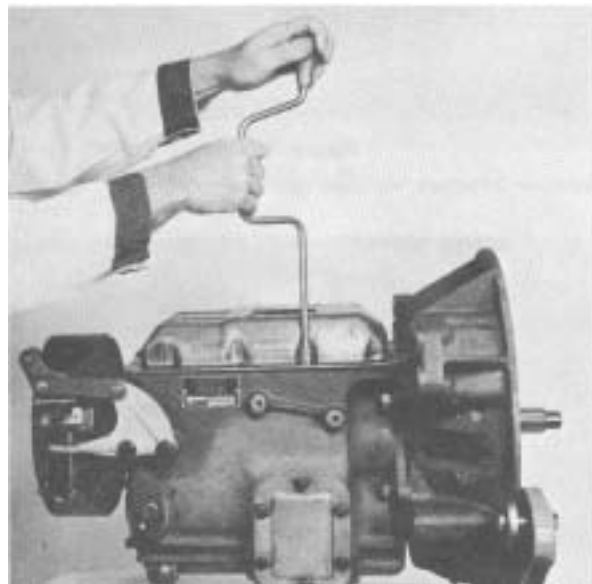


Figure 86 - Tighten shift support cover bolts 20 to 25 ft. lbs. torque [27,3 - 33,8 N.m.].



Figure 87 - Install remove control or shift control top, tighten bolts 20 to 25 ft. lbs. torque [27,2 - 33,8 N.m.].

USE FOLLOWING PROCEDURE FOR DIECAST COVER DISASSEMBLY AND REASSEMBLY (Fabricated Rails)

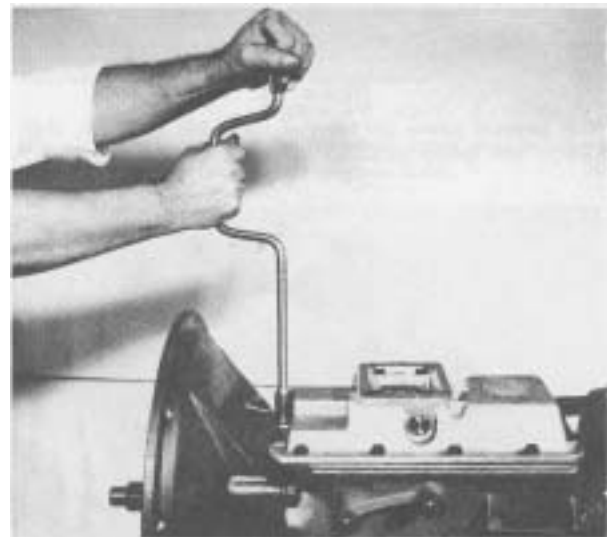


Figure 88 - Remove remote control or shift tower from control cover. Remove control cover capscrew and lock-washers.



Figure 89 - Remove control cover assembly from transmission. Remove backup switch.

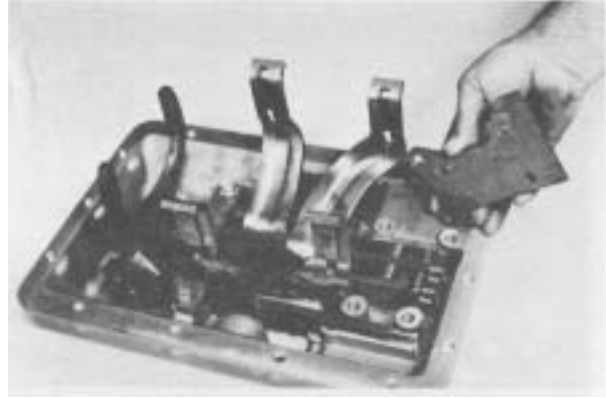


Figure 92 - Remove front rail support.



Figure 90 - With control cover in neutral, pry 4th & 5th shift fork to 4th speed position (toward the rear of cover).

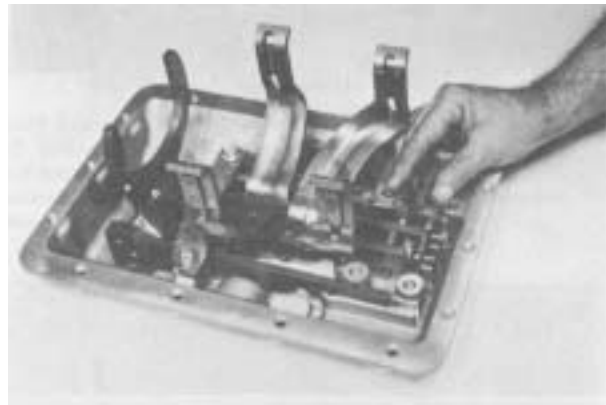


Figure 93 - Remove interlock tapered pin supports

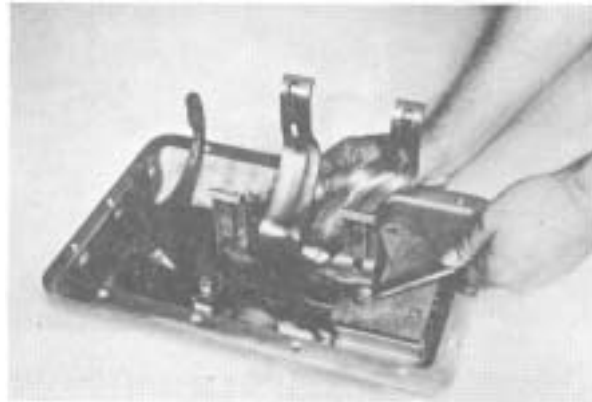


Figure 91 - Remove front rail support cap screws.

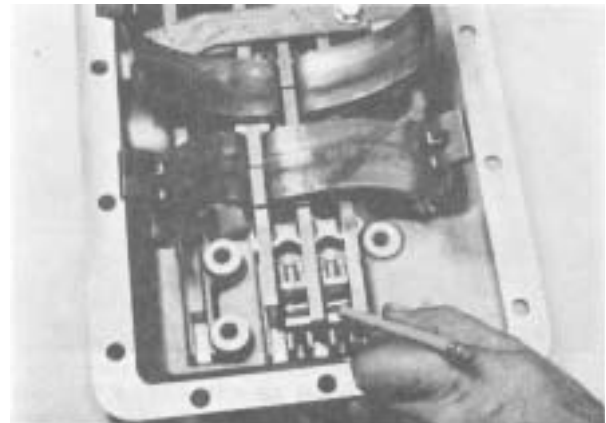


Figure 94 - Note position of interlock tapered pins for reassembly.

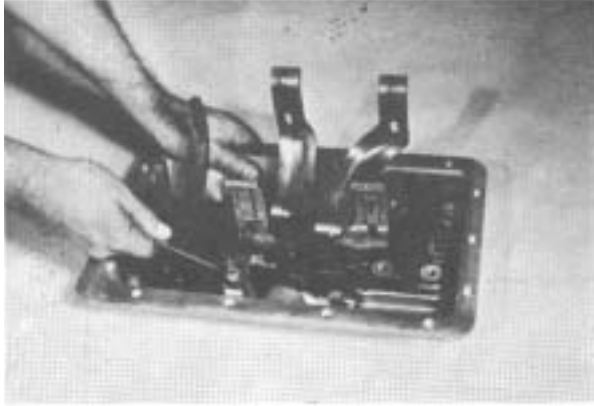


Figure 95 - Remove rear rail support capscrews.

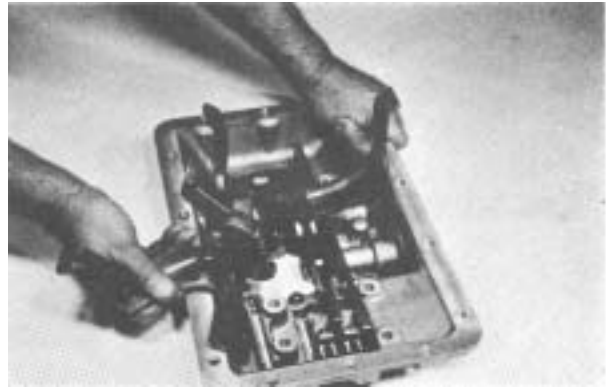


Figure 98 - Remove 4th, 5th, 2nd & 3rd shift fork and rail assembly. (See Caution in Figure 99).

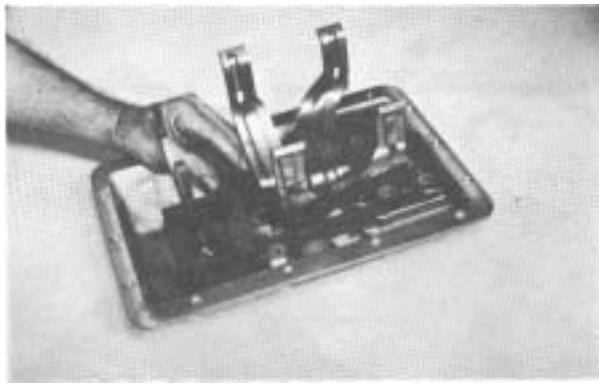


Figure 96 - Remove rear rail support



Figure 99 - Use caution as not to lose interlock cross pin, interlock tapered pins or mesh lock poppet balls.

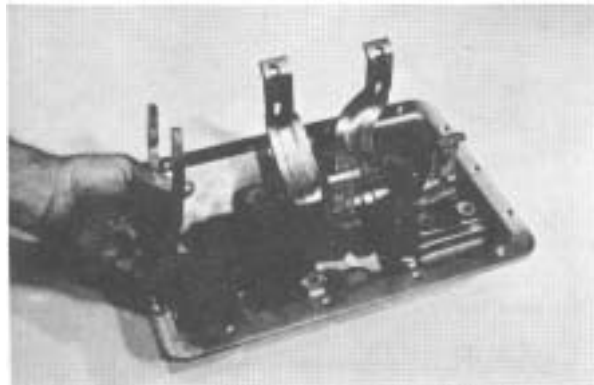


Figure 97 - Remove 1st & reverse shift fork and rail assembly.

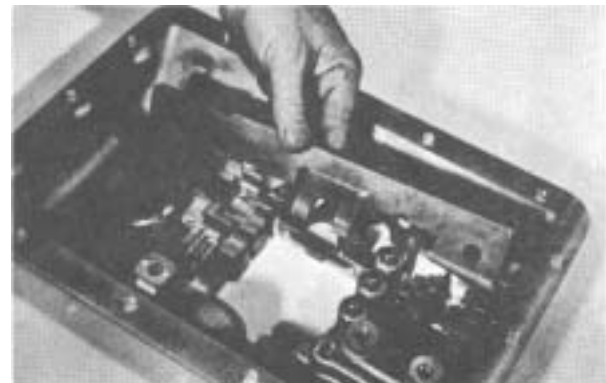


Figure 100 - Remove 1st & reverse shift rail.



Figure 101 - Remove mesh lock poppet balls, quantity 4.

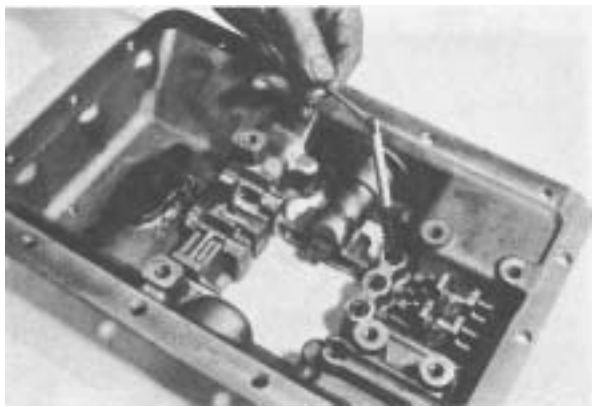


Figure 102 - Remove poppet springs, quantity 4.

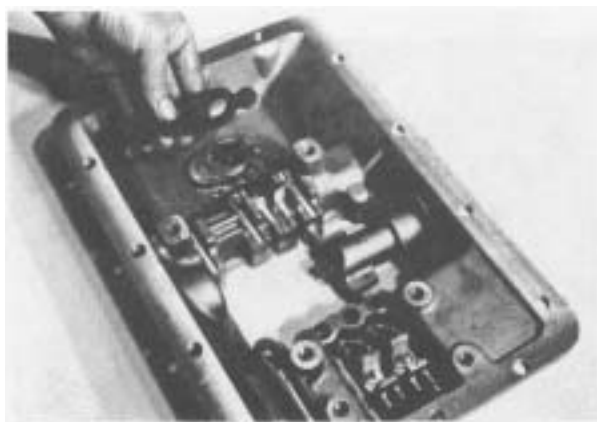


Figure 103 - Remove 1st & reverse rocker arm.

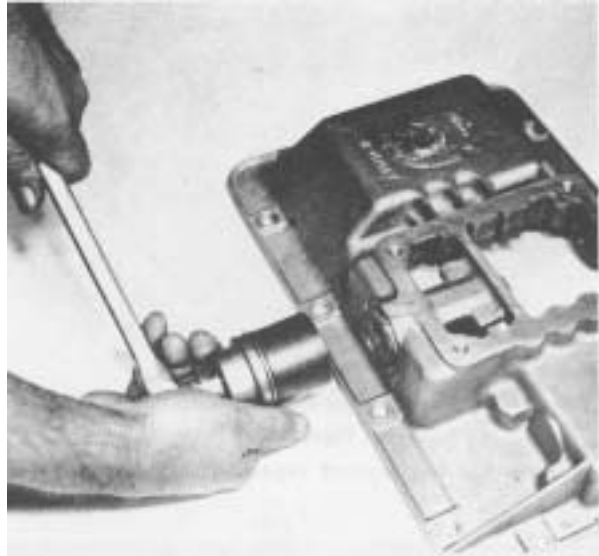


Figure 104 - Remove reverse latch plunger spring retaining plug.

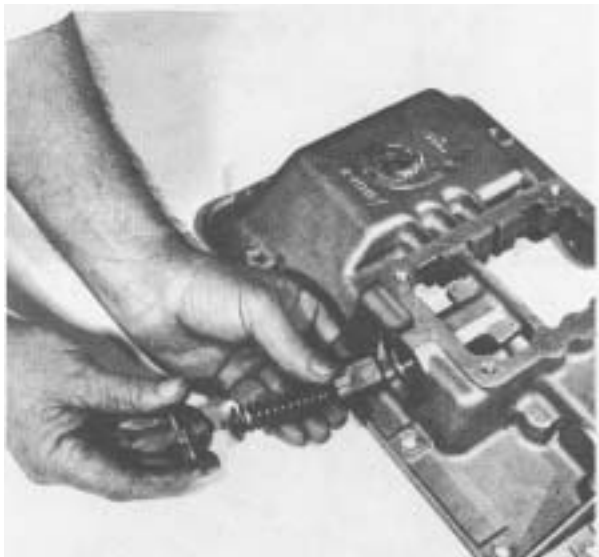


Figure 105 - Remove reverse latch plunger spring and plunger.

SEE CLEANING AND INSPECTION PROCEDURE, PAGES 10-11.

DIECAST CONTROL REASSEMBLY



Figure - 106 - If fork bushings are worn, secure fork in a vise equipped with soft jaws and remove worn bushings with a drift. Install new bushings in fork. Turn fork over on anvil of vise and secure bushing in fork using a prick punch and upsetting bushing metal on outside of fork.

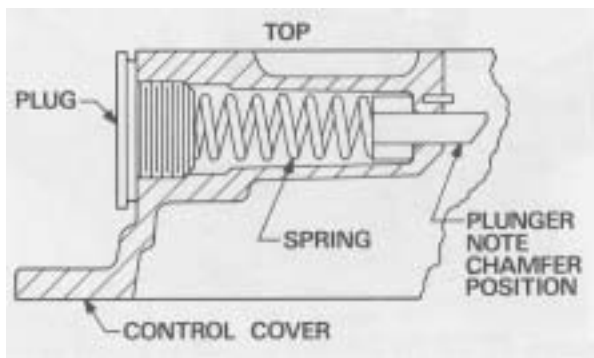


Figure 107 - Install reverse latch plunger, spring and retaining plug. Tighten plug securely.



Figure 108 - Position 1st & reverse rocker arm on pivot pin as shown.



Figure 109 - Install poppet springs, quantity 4.

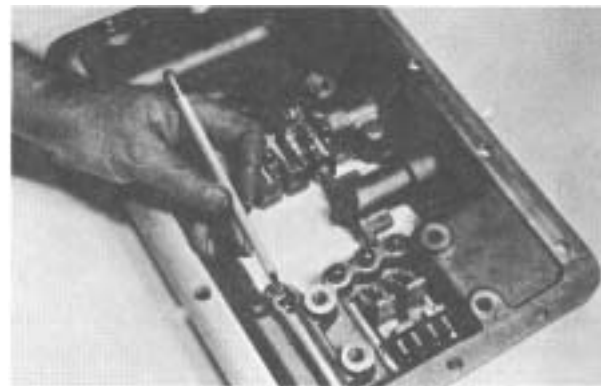


Figure 110 - Install mesh lock poppet balls, quantity 4. Note 1st & reverse shift fork rail poppet ball in pocket.



Figure 111 - Align one tapered interlock cross pin with hole in 1st & reverse shift rail. Position rail on poppet ball with rail in neutral position.

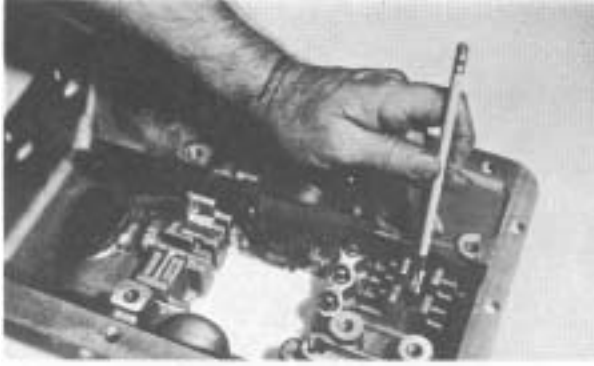


Figure 112 - Note position of tapered interlock cross pin in relation to rail.



Figure 115 - Install 2nd interlock tapered pin. Align pin with interlock cross pin hole.

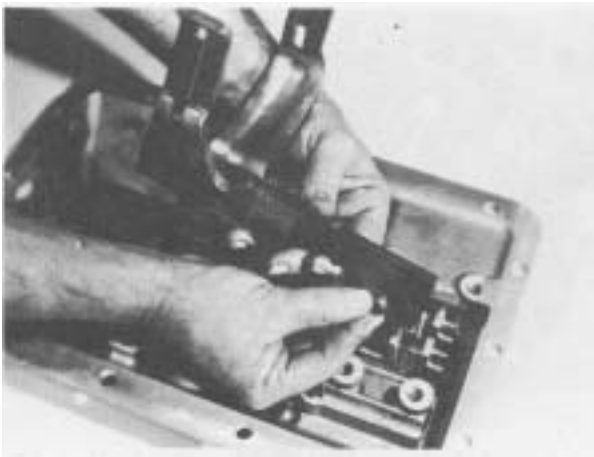


Figure 113 - Install interlock cross pin in 2nd & 3rd shift rail.

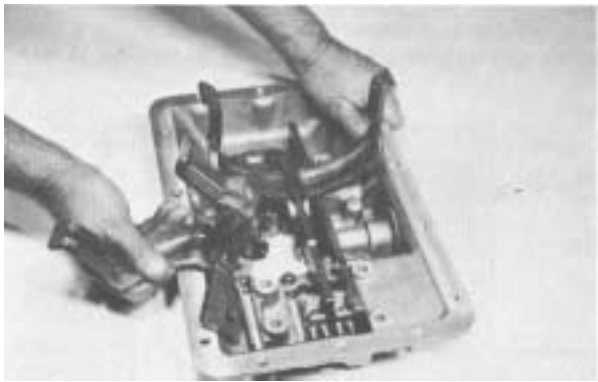


Figure 116 - Position 4th & 5th shift fork and rail on poppet ball in neutral.



Figure 114 - Position 2nd & 3rd shift rail on poppet ball in neutral position with interlock pin aligned with 1st interlock tapered pin.



Figure 117 - Slightly raise rear of 4th & 5th shift rail and align 2nd interlock tapered pin with cross hole in 4th & 5th shift rail.

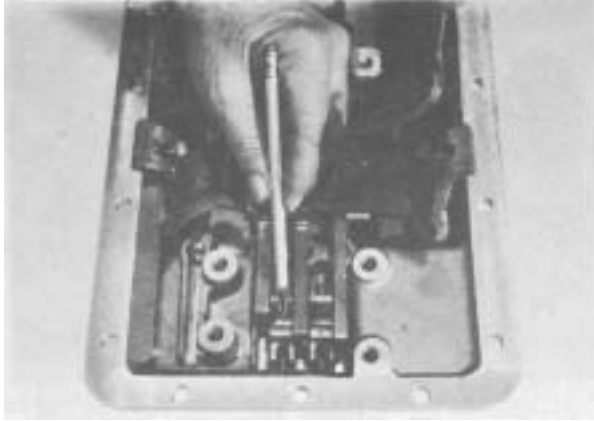


Figure 118 - Note position of tapered interlock pins and shift rails.

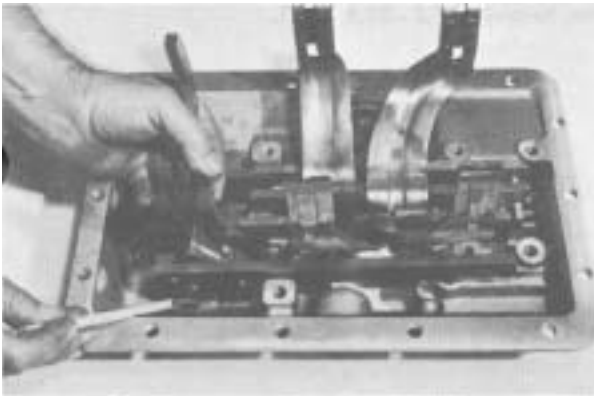


Figure 119 - Install 1st & reverse shift fork and rail assembly on poppet ball in a neutral position. Align 1st & reverse rocker arm in notch at rear of rail as shown.

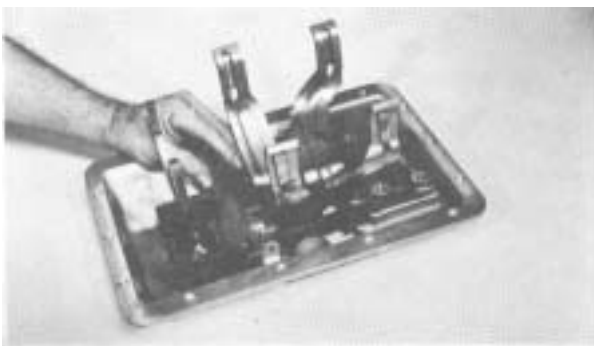


Figure 120 - Position rear rail support

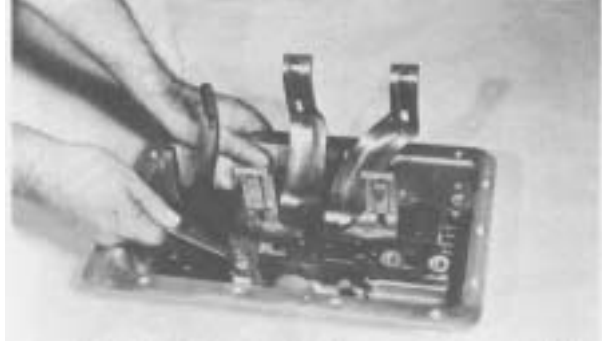


Figure 121 - Install rail support capscrews and washers. Tighten capscrews slightly.

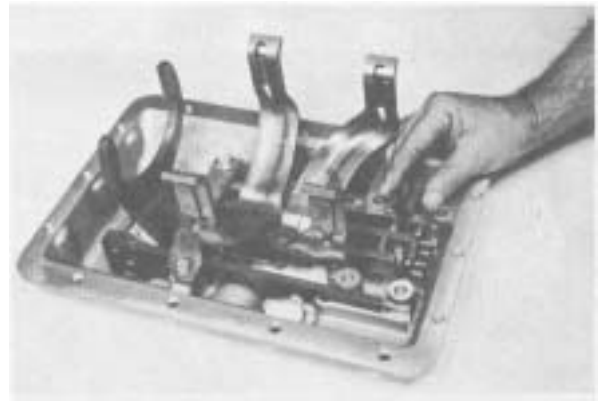


Figure 122 - Install interlock tapered pin supports. Tap 4th & 5th shift fork to the rear. (4th speed position).

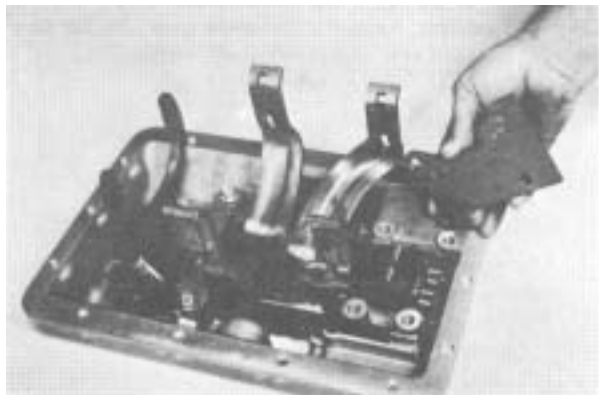


Figure 123 - Position front rail support and install capscrews and washers.

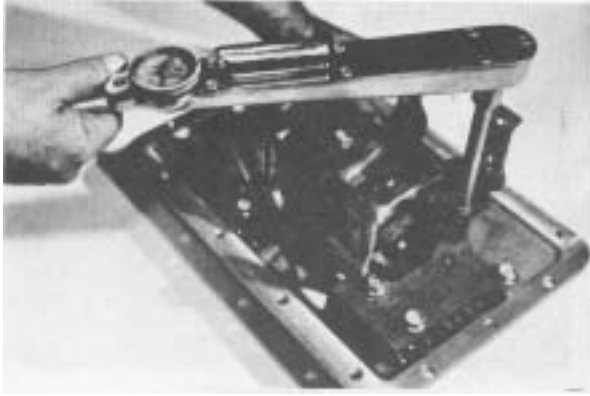


Figure 124 - Tighten front and rear support cap screws 20 to 25 ft. lbs. torque [27,2 - 33,8 N,m]. Tap 4th & 5th shift fork and rail assembly forward to a neutral position.



Figure 126 - Install center rear cap screws first and tighten 20 to 25 ft. lbs. torque [27,2 - 33,8 N,m]. Install center front screw second and tighten 20 to 25 ft. lbs torque [27,2 - 33,8 N,m]. Tighten remaining cap screws 20 to 25 ft. lbs torque [27,2 - 33,8 N,m].



Figure 125 - With transmission in neutral, position control cover over gears aligning shift forks in shift cover with gear shift hubs. If control cover is in neutral and transmission is in neutral, transmission drive gear should turn without brake drum or output shaft turning.

SHIFT CONTROL DISASSEMBLY (Round Rails)



Figure 1 - Remove front and rear rail support capscrews.

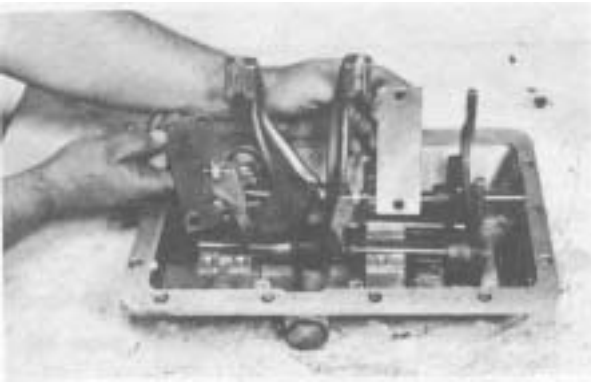


Figure 2 - Remove front and rear rail supports

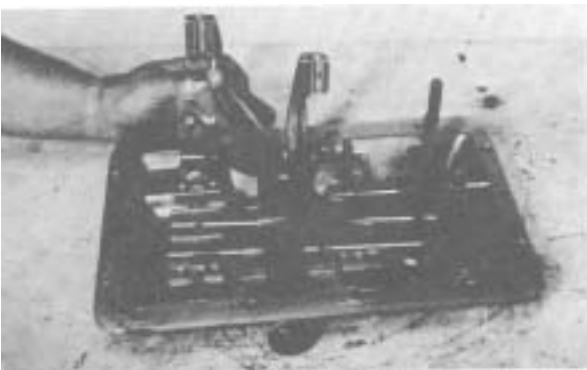


Figure 3 - Remove the 4th and 5th shift fork and rail assembly.

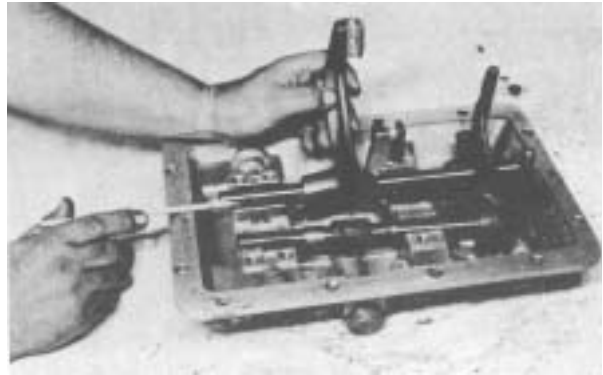


Figure 4 - Remove 2nd & 3rd shift fork and rail assembly. CAUTION: Do not loss interlock cross pin.

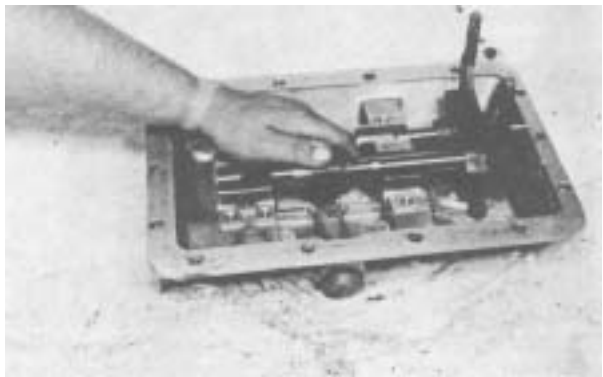


Figure 5 - Remove 1st & reverse shift fork, rail and lug assembly.

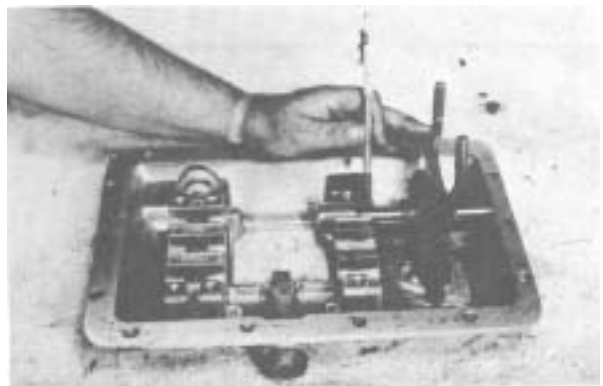


Figure 6 - Using a small magnet remove the 1st and reverse shift fork rod lock pin.

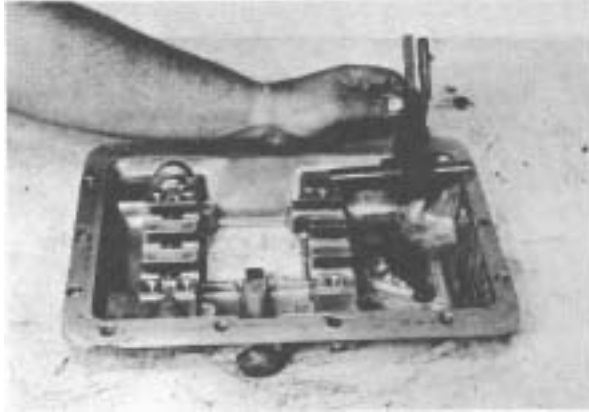


Figure 7 - Remove first & reverse shift fork and rail assembly.

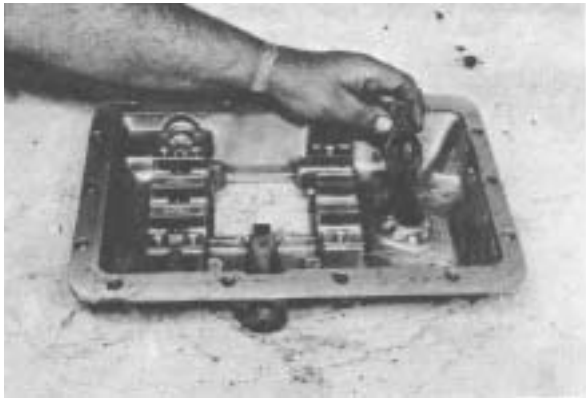


Figure 8 - Remove 1st & reverse rocker arm.

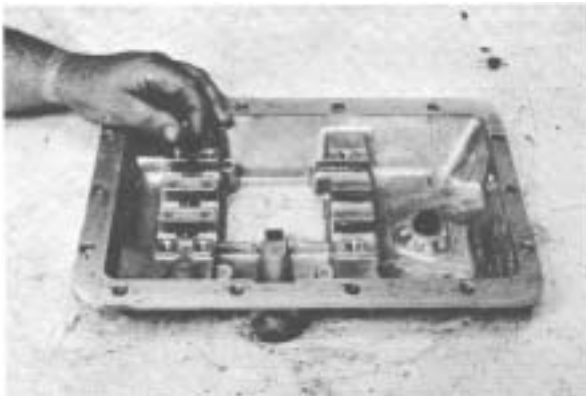


Figure 9 - Remove mesh lock spring and lock ball - 3 each. Remove crossover interlock balls - 4 each.

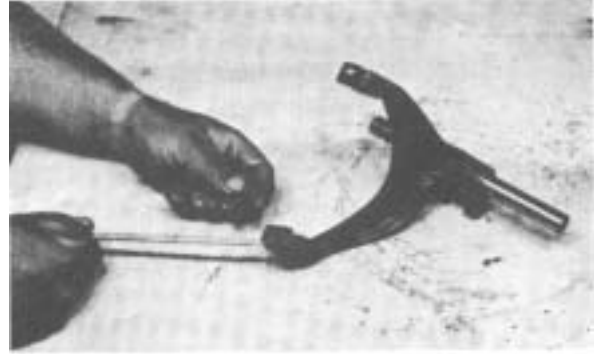


Figure 10 - If the second, third, fourth or fifth shift fork bushing is to be replaced, remove worn bushings from fork. Install new bushing and bend bushings tab over top and bottom of fork.

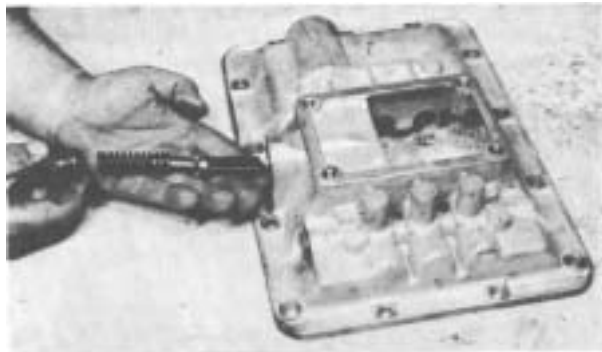


Figure 11 - Remove reverse latch plunger, pin and spring.

See Cleaning and Inspection Section, Page 10.

REASSEMBLY



Figure 12 - Install reverse latch plunger, spring, pin and plunger spring plug.

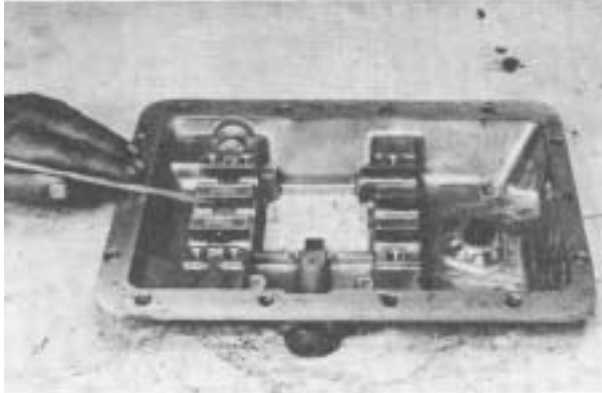


Figure 13 - Position crossover interlock balls in cover cross bores. Two balls in cover cross bore between 1st & reverse rail groove, and 2nd & 3rd rail groove and two balls in cover cross bore between 2nd & 3rd rail groove, and 4th & 5th rail groove. (See cross-section illustration Figure 13-A).

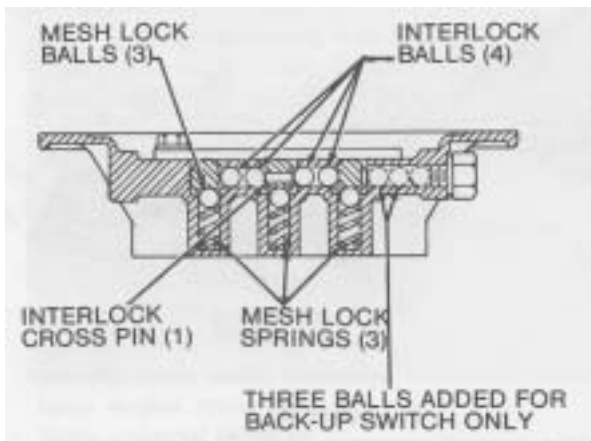


Figure 13-A

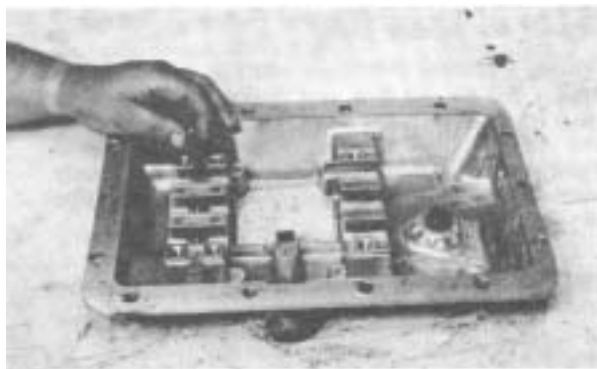


Figure 14 - Position the mesh lock spring and ball, three each, in spring pockets. (See cross-section illustration Figure 13-A).

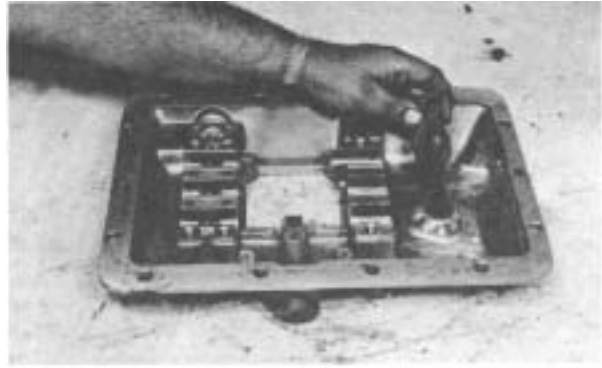


Figure 15 - Position 1st & reverse rocker arm on pivot pin.

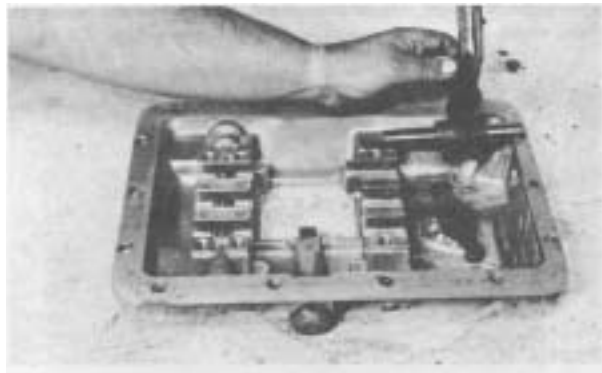


Figure 16 - Install 1st & reverse shift fork and rail assembly in control housing. Install shift rail lock pin to position rail in control housing.

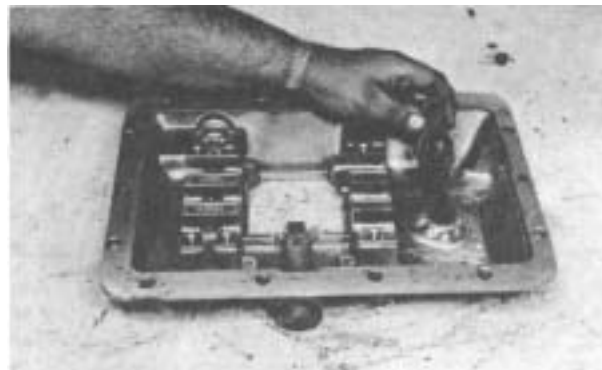


Figure 17 - Install 1st & reverse shift lug, rocker lug, shift rail and spacers in rail groove over mesh lock ball and spring. NOTE: Position widest spacer between shift lug and front support. The narrower spacer between the shift lug and center support.

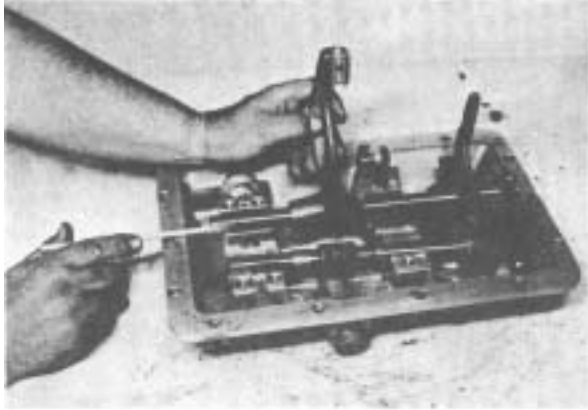


Figure 18 - Install interlock cross pin in 2nd & 3rd shift rail. Position 2nd & 3rd shift rail and fork assembly in rail groove over mesh lock ball and spring. Make certain cross pin is in position in rail. (See Figure 13-A).

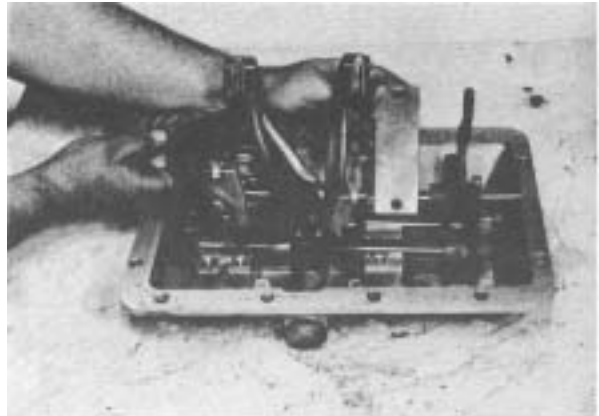


Figure 20 - Position front rail support shift rails and install cap screws. Position rear support over rails and install cap screws.

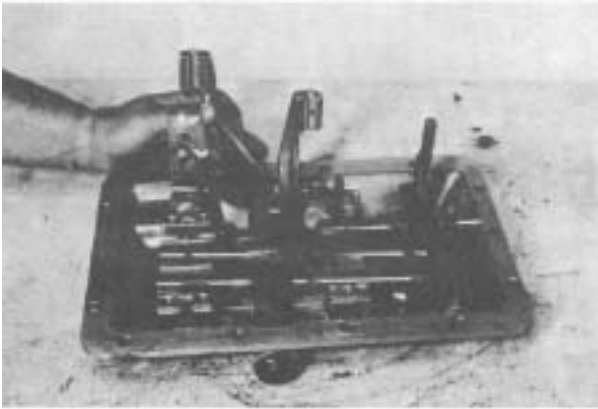


Figure 19 - Position 4th & 5th shift rail and fork assembly in rail groove over mesh lock ball and spring.



Figure 21 - Tighten support cap screws 20 to 25 ft. lbs. torque [27,2 - 33,8 N.m].

Test Cover for Double Shift:

Pry 4th & 5th shift fork and rail out of neutral position. Try to pry 1st & reverse shift fork and rail out neutral position. 1st & reverse fork should not shift. If it does, interlock cross pin or interlock cross over balls were not assembled correctly. Disassemble cover and correct cross over. (See illustration Figure 13-A).

NOTE: Install control cover cap screws in sequence explained in Figure 126.

TROUBLESHOOTER'S TRANSMISSION CHECKLIST

- 1. NOISE ARISING IN NEUTRAL**
 - Misalignment of transmission
 - Worn transmission bearings
 - Scuffed gear tooth contact surfaces on gears
 - Worn mainshaft gear bushings
 - Worn or rough reverse idler gear
 - Sprung or work countershaft
 - Excessive backlash in constant mesh gear
 - Work mainshaft pilot bearing
 - Incorrect lubricant
 - Low lubricant level
 - Noisy main drive gear bearing

- 2. NOISE ARISING IN GEAR**
 - Worn or rough mainshaft rear bearing
 - Sliding gear teeth rough, chipped, tapered
 - Excessive end play on mainshaft gears
 - Noisy speedometer gears
 - (See Conditions under #1)

- 3. NOISE ARISING OUTSIDE**
 - Out-of-balance fan
 - Defective torsional dampener
 - Out-of-balance crankshaft
 - Out-of-balance flywheel
 - Out-of-balance clutch assembly
 - Loose engine mountings
 - Worn universal joints
 - U-joints improperly installed
 - Misaligned or sprung driveshaft
 - Incorrect driveshaft assembly
 - Out-of-balance driveshaft

- 4. DIFFICULT SHIFTING**
 - Improperly operating clutch
 - Sliding gear or shift hubs tight on mainshaft splines
 - Damaged chamfer on sliding gear teeth
 - Burred mainshaft splines
 - Misaligned mainshaft
 - Damaged or worn synchronizer assembly
 - Improper linkage adjustment
 - Worn or sprung shift fork

- 5. STICKING IN GEAR**
 - Improperly operating clutch
 - Sliding gear or shift hubs tight on mainshaft splines
 - Misaligned mainshaft
 - Improper linkage adjustment

- 6. SLIPPING OUT OF DIRECT**
 - Misaligned of transmission on engine
 - Worn pinion gear teeth
 - Worn clutching teeth on shift hub
 - Insufficient tension on detent balls
 - Improper linkage adjustment
 - Excessive shift lever whip action

- 7. SLIPPING OUT OF FIRST OR REVERSE**
 - First or reverse sliding gear splines worn
 - Sliding gear teeth worn or tapered
 - Worn mainshaft splines
 - Worn countershaft first speed gear
 - Partial engagement
 - Improper linkage adjustment

- 8. SLIPPING OUT OF OTHER SPEEDS**
 - Excessive clearance between mainshaft gear and mainshaft
 - Excessive end play of mainshaft gear on mainshaft
 - Worn clutching teeth
 - Weak detent ball springs
 - Improper linkage adjustment

Copyright Eaton Corporation, 2012. Eaton hereby grant their customers, vendors, or distributors permission to freely copy, reproduce and/or distribute this document in printed format. It may be copied only in its entirety without any changes or modifications. THIS INFORMATION IS NOT INTENDED FOR SALE OR RESALE, AND THIS NOTICE MUST REMAIN ON ALL COPIES.

Note: Features and specifications listed in this document are subject to change without notice and represent the maximum capabilities of the software and products with all options installed. Although every attempt has been made to ensure the accuracy of information contained within, Eaton makes no representation about the completeness, correctness or accuracy and assumes no responsibility for any errors or omissions. Features and functionality may vary depending on selected options.

For spec'ing or service assistance, call 1-800-826-HELP (4357) or visit www.eaton.com/roadranger. In Mexico, call 001-800-826-4357.

Roadranger: Eaton and trusted partners providing the best products and services in the industry, ensuring more time on the road.

Eaton Corporation

Vehicle Group
P.O. Box 4013
Kalamazoo, MI 49003 USA
800-826-HELP (4357)
www.eaton.com/roadranger

Printed in USA

For parts or service call us
Pro Gear & Transmission, Inc.



1 (877) 776-4600

(407) 872-1901

parts@eprogear.com

906 W. Gore St.

Orlando, FL 32805

